

I n s t r u k c j a M o n t a ż u

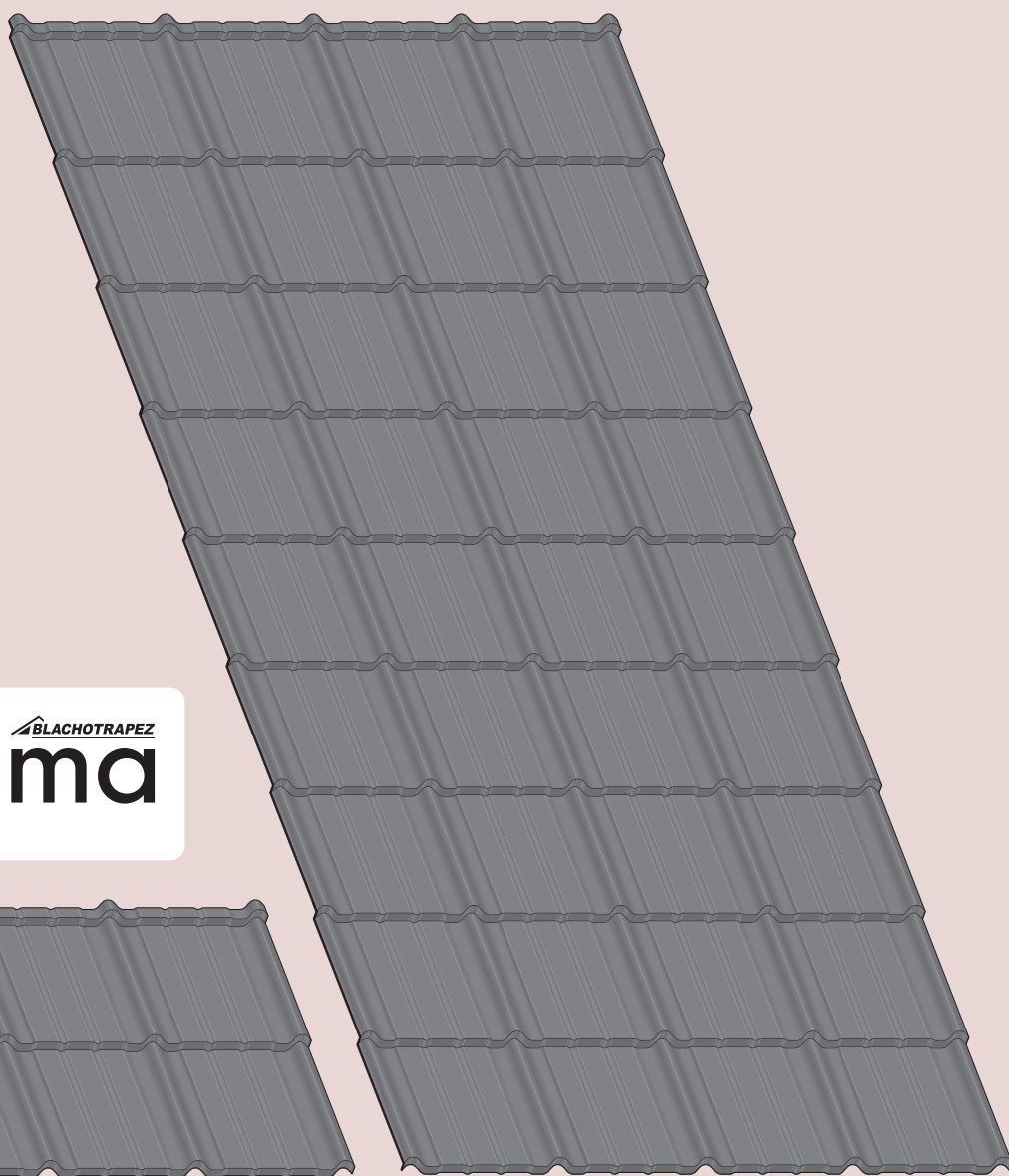

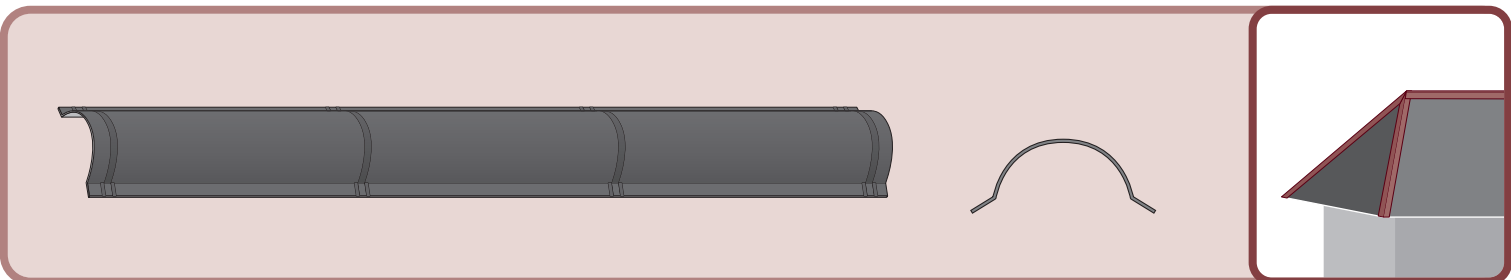

1

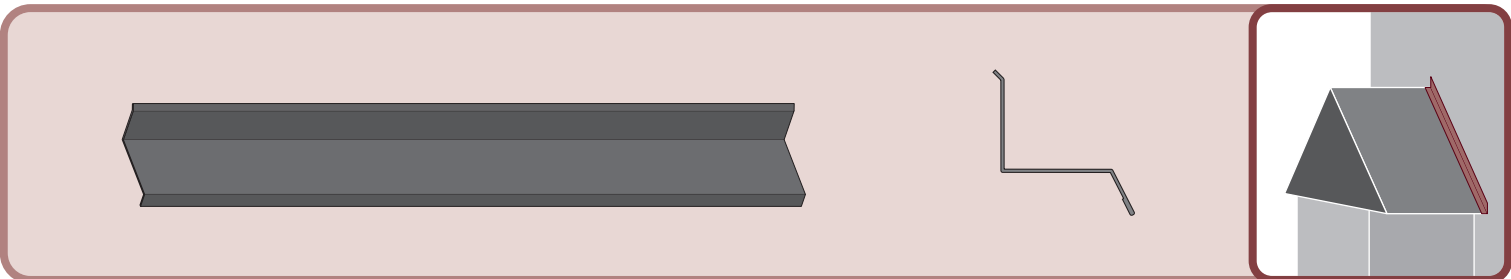
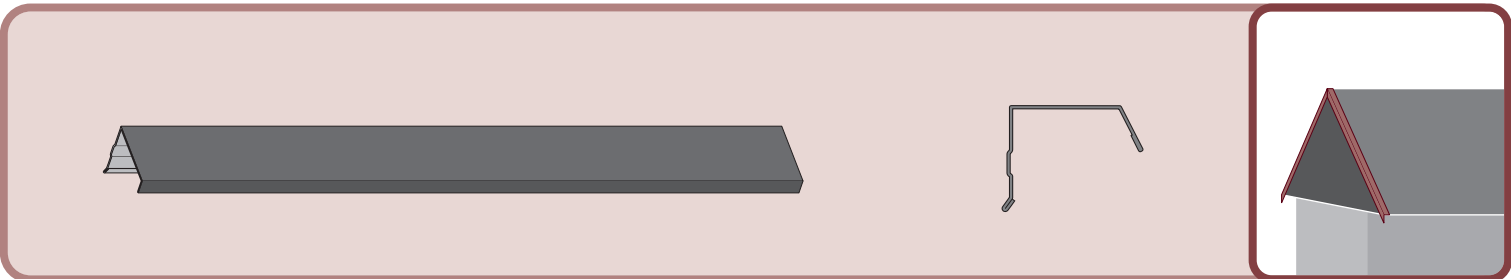
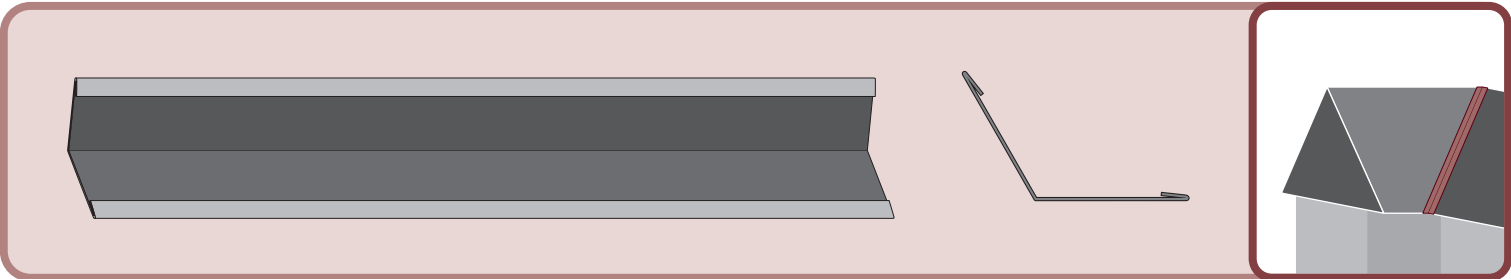
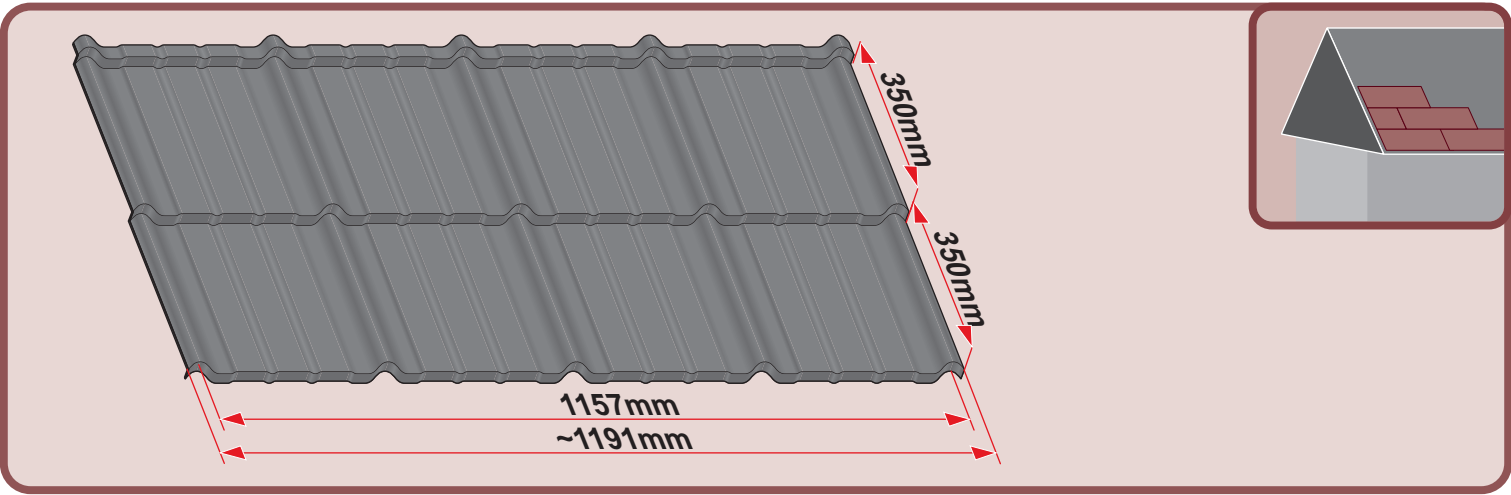
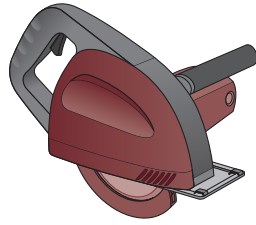
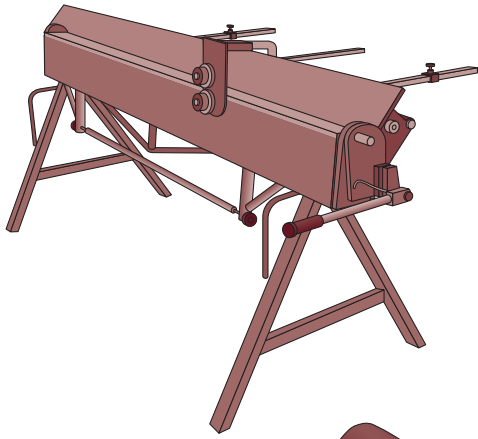

max 4000 r/min

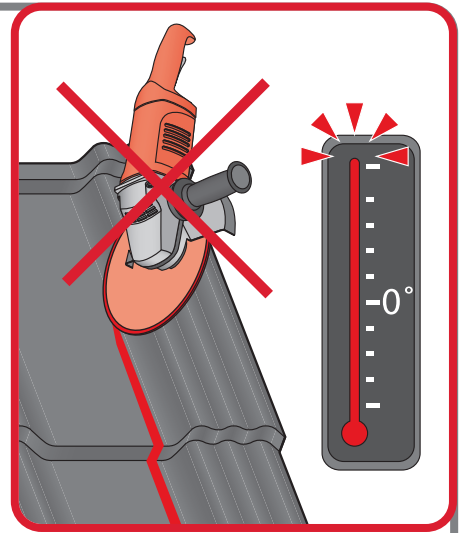
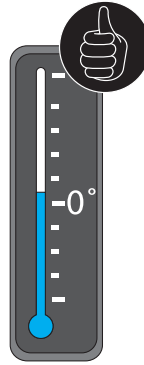
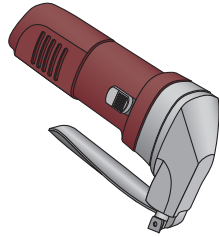

2

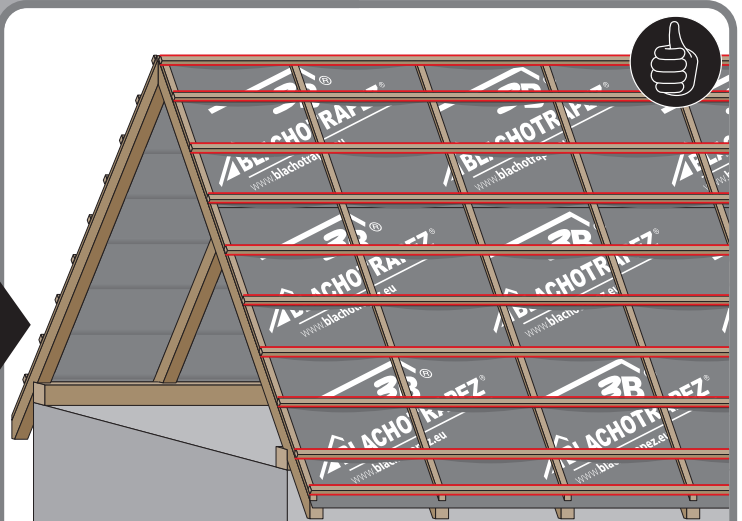
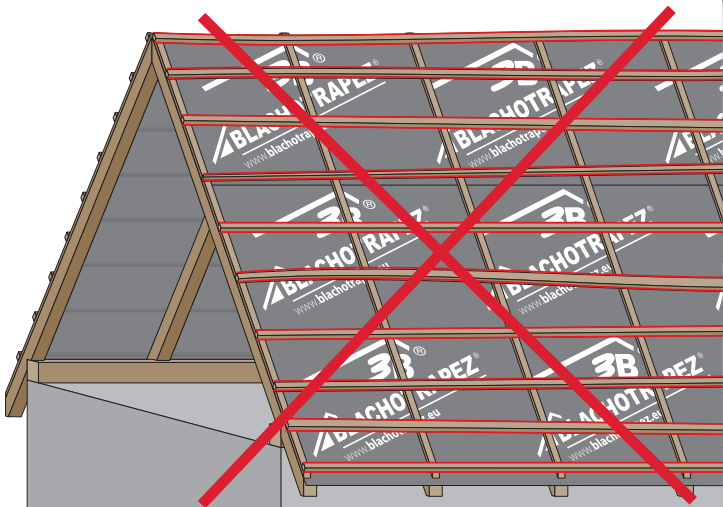
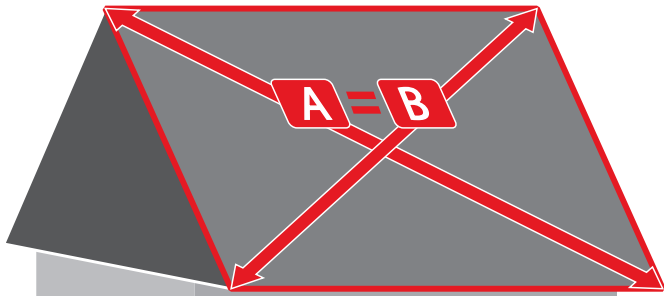

3

3a

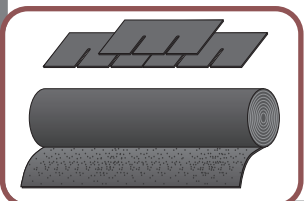
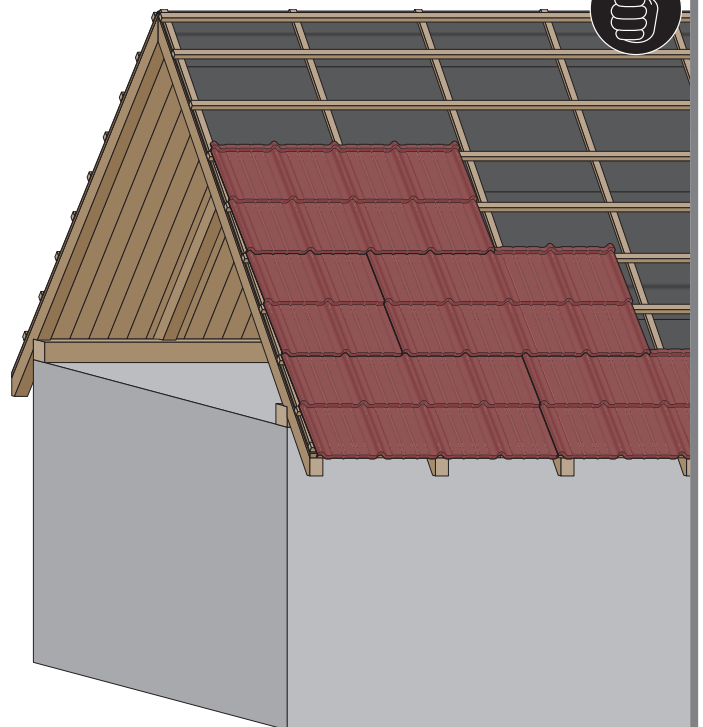
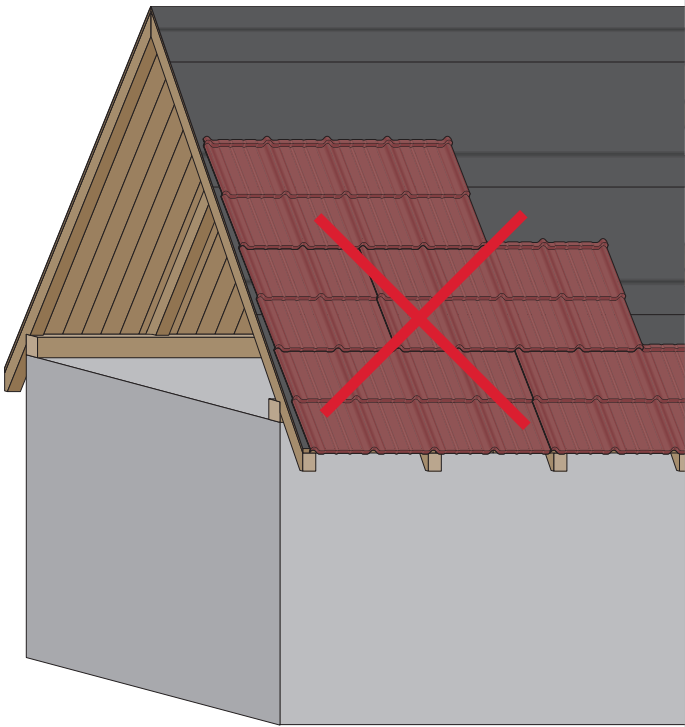
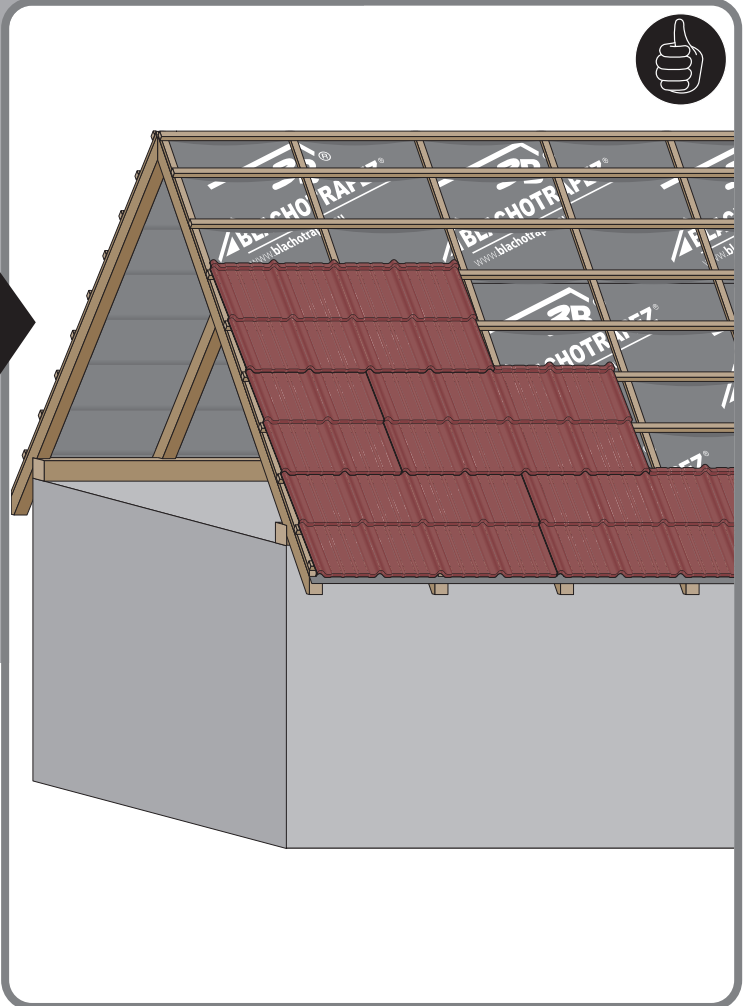
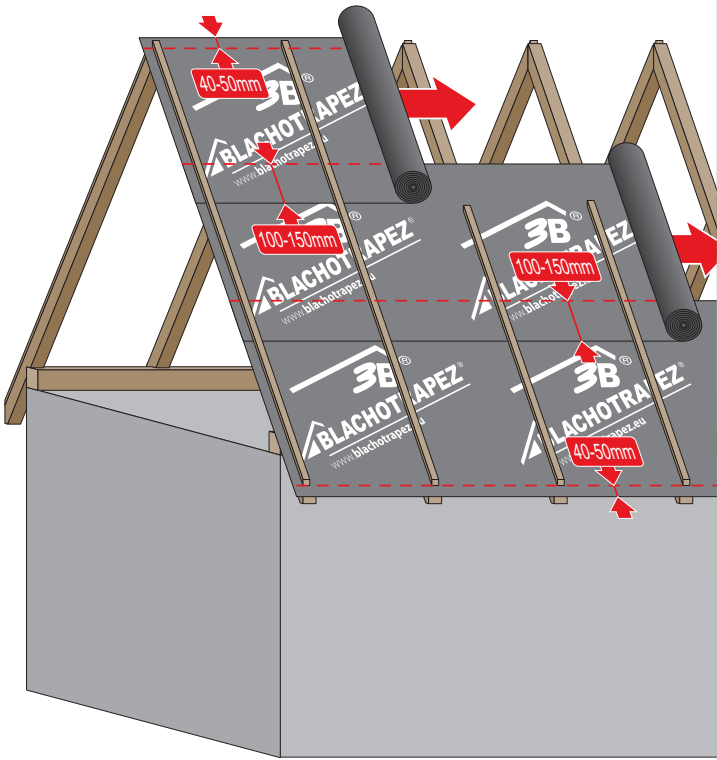

3b

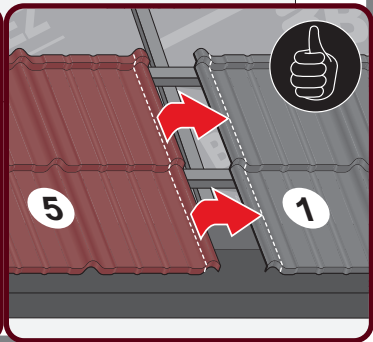
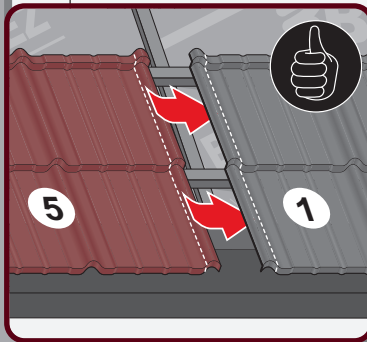
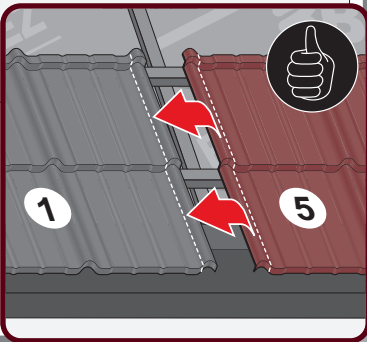
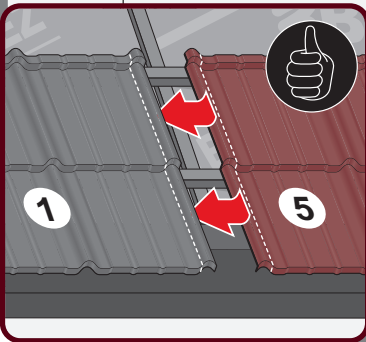
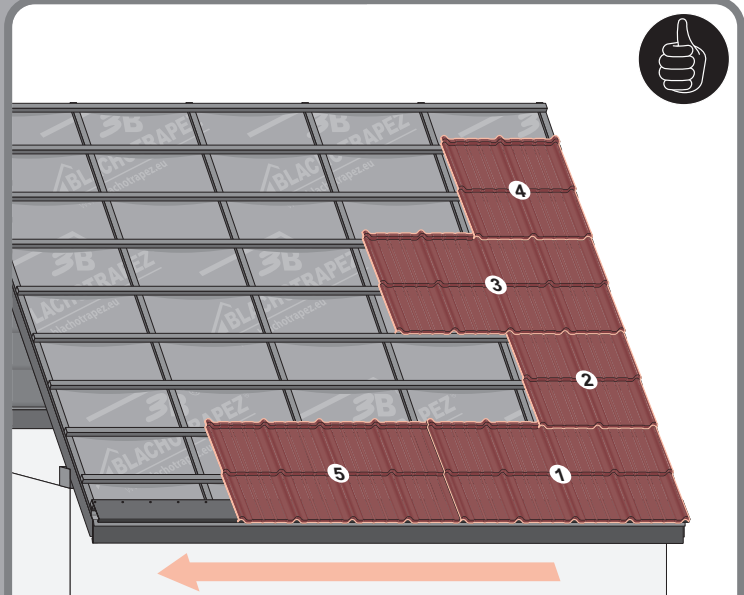
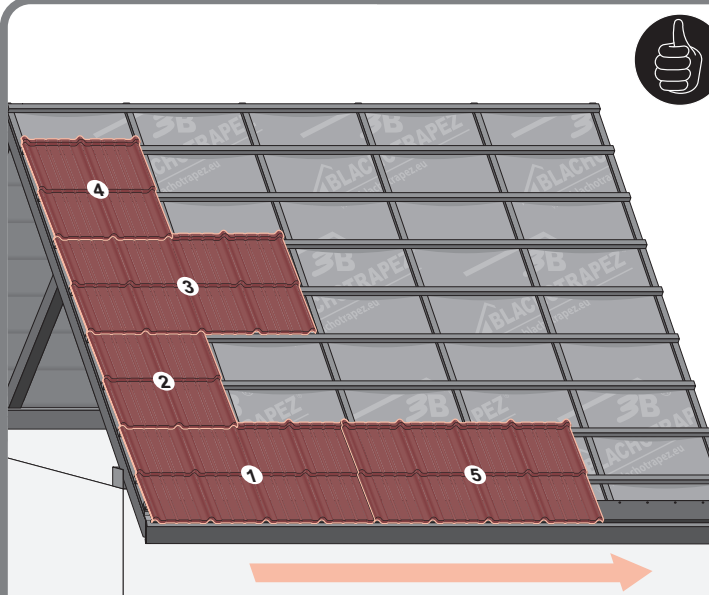
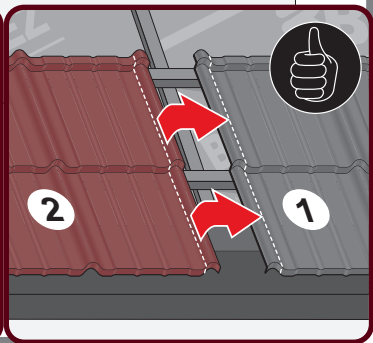
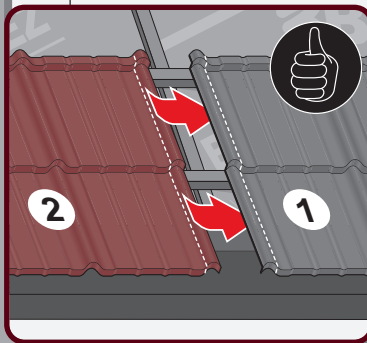
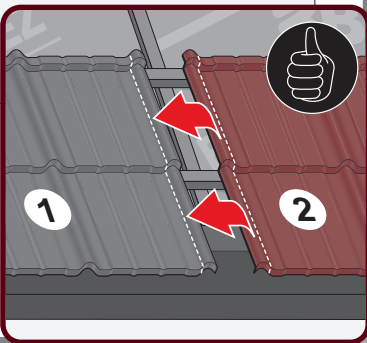
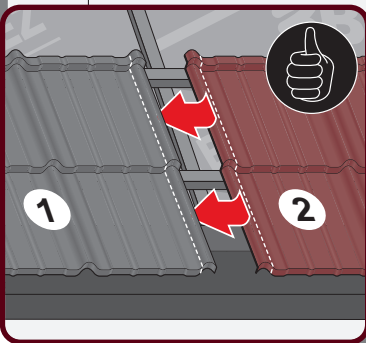
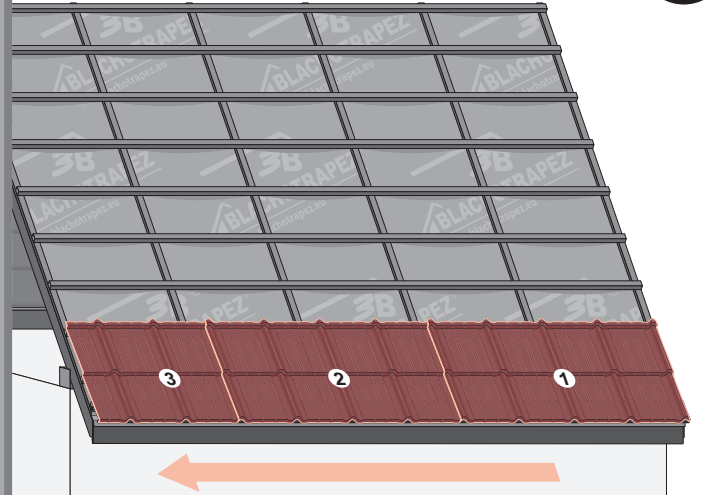
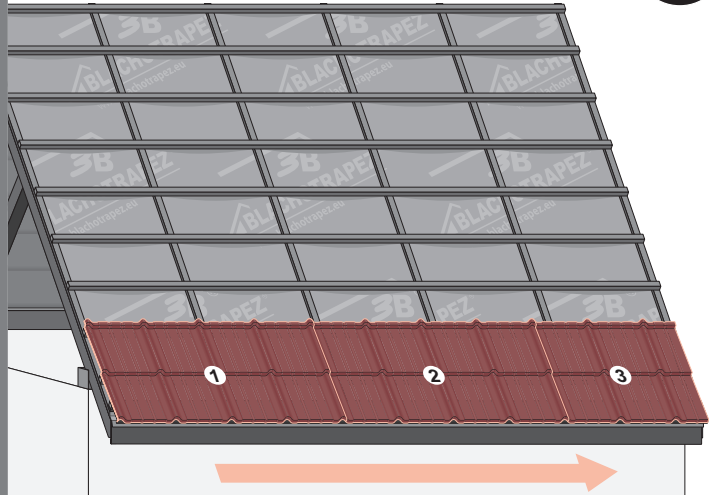

3c

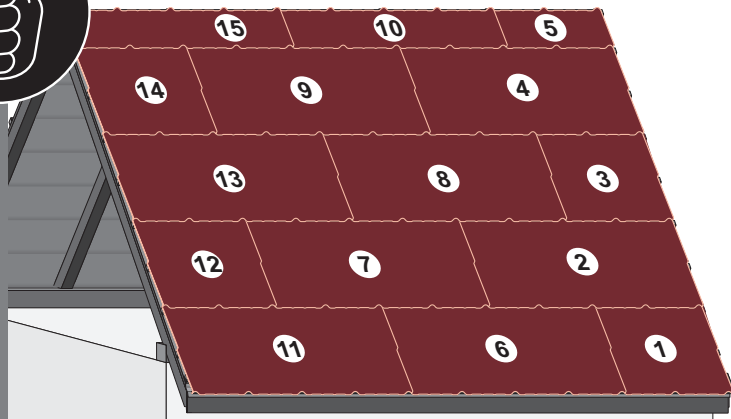

3d

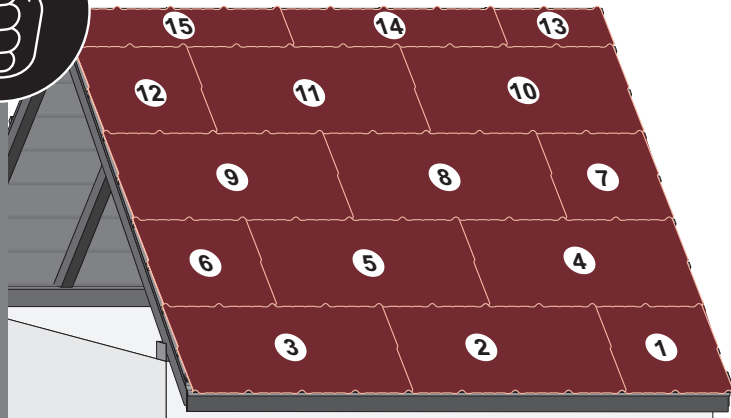

3e

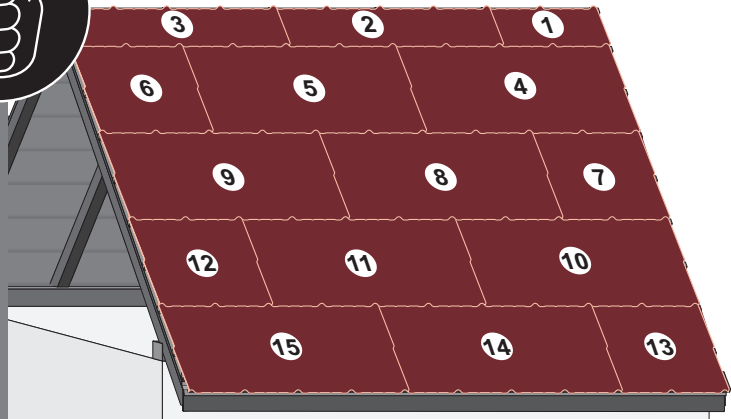
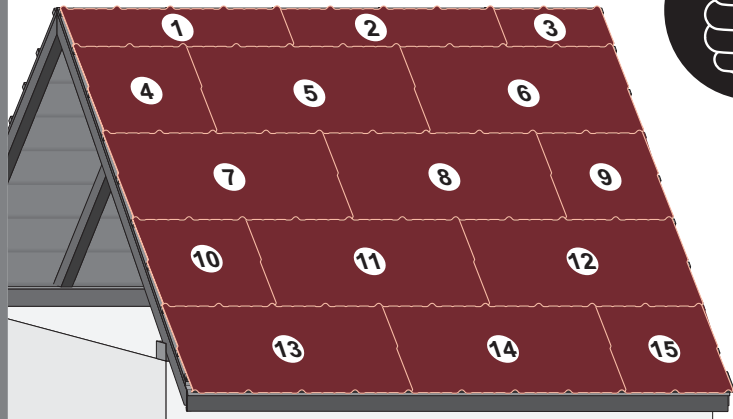

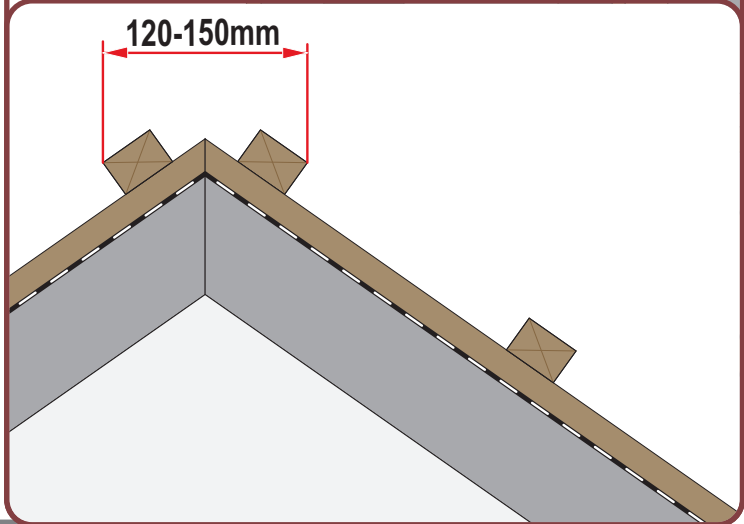
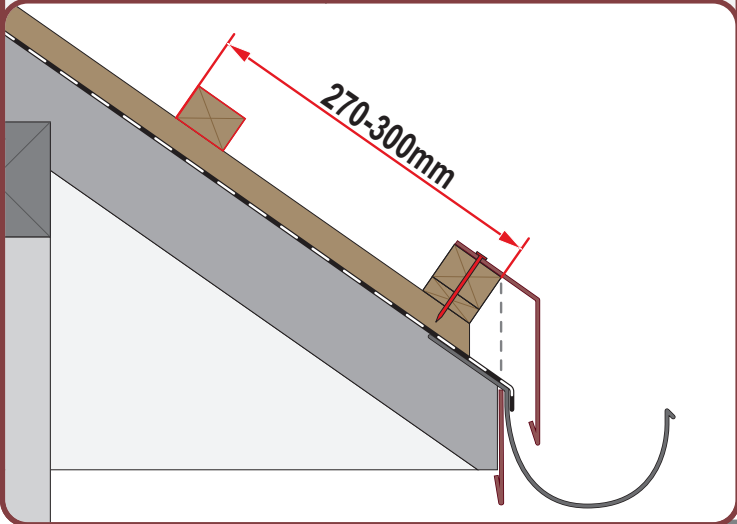
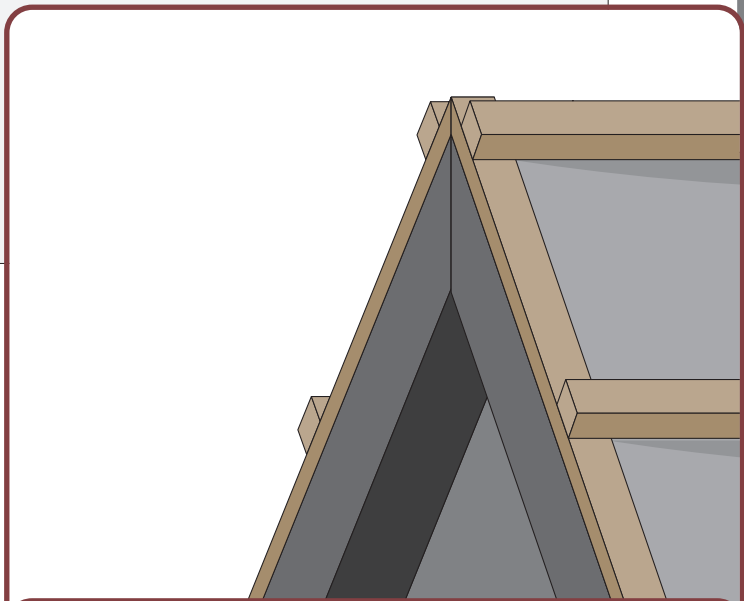
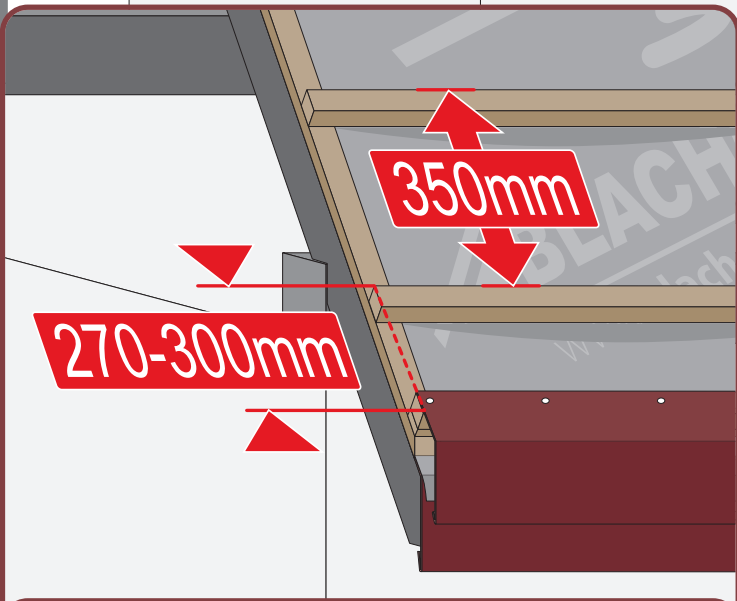
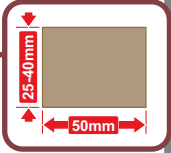
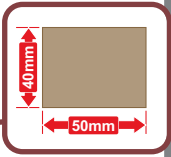
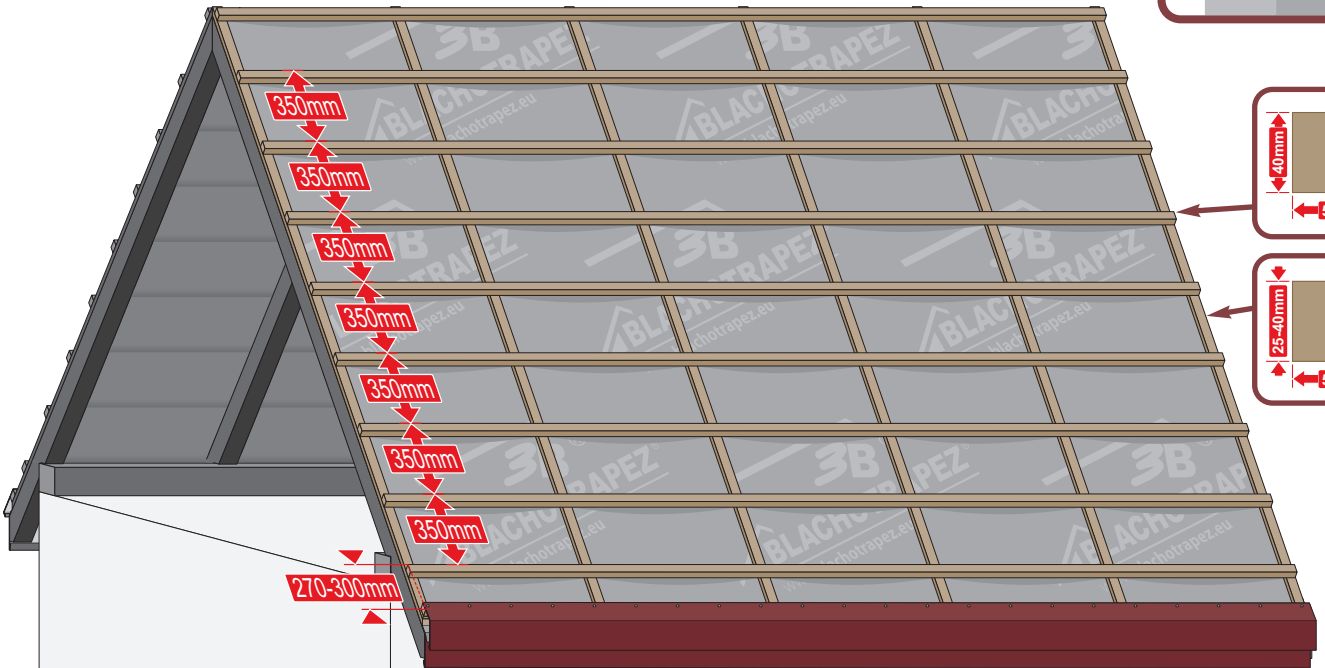
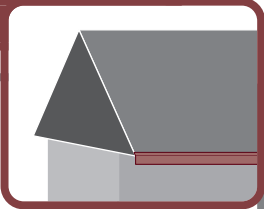

5a

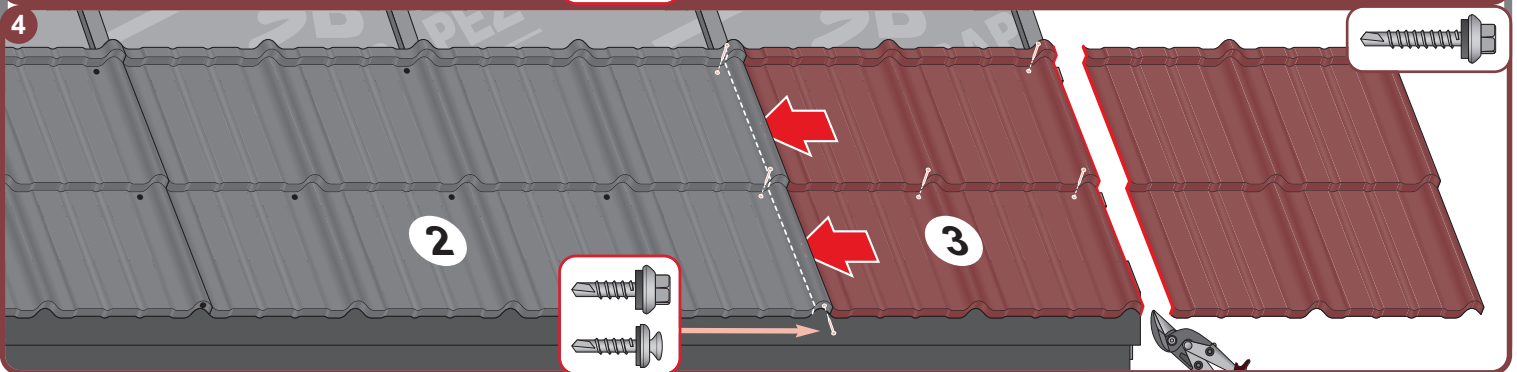
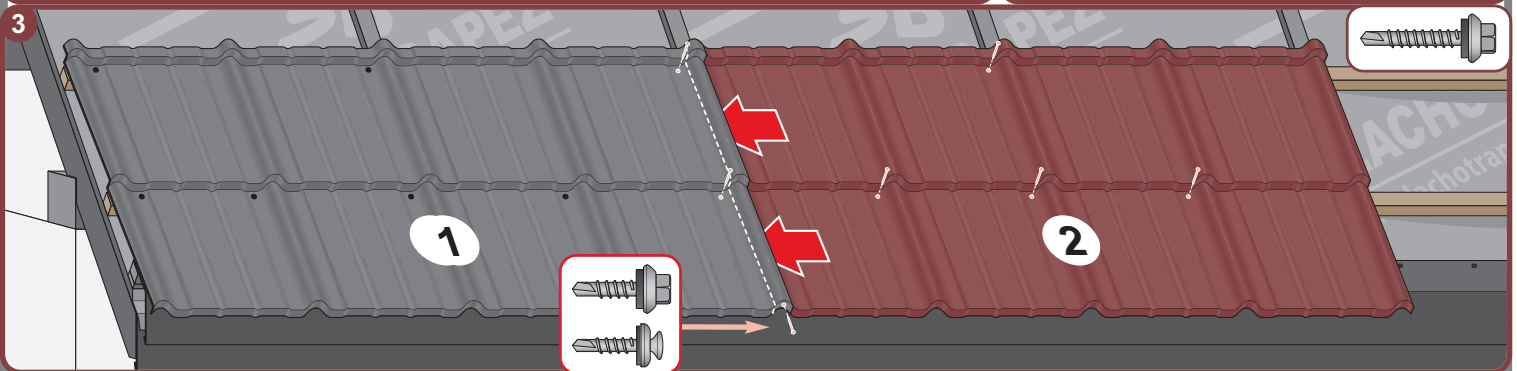
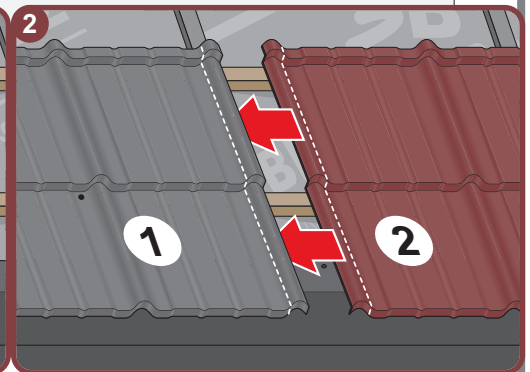
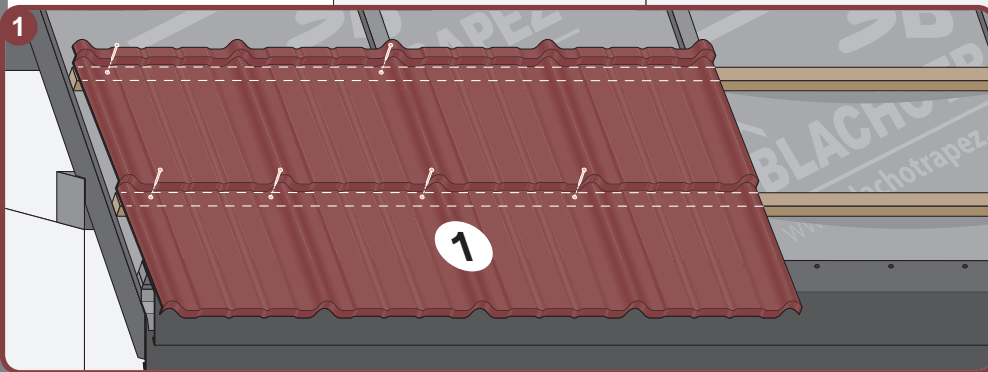
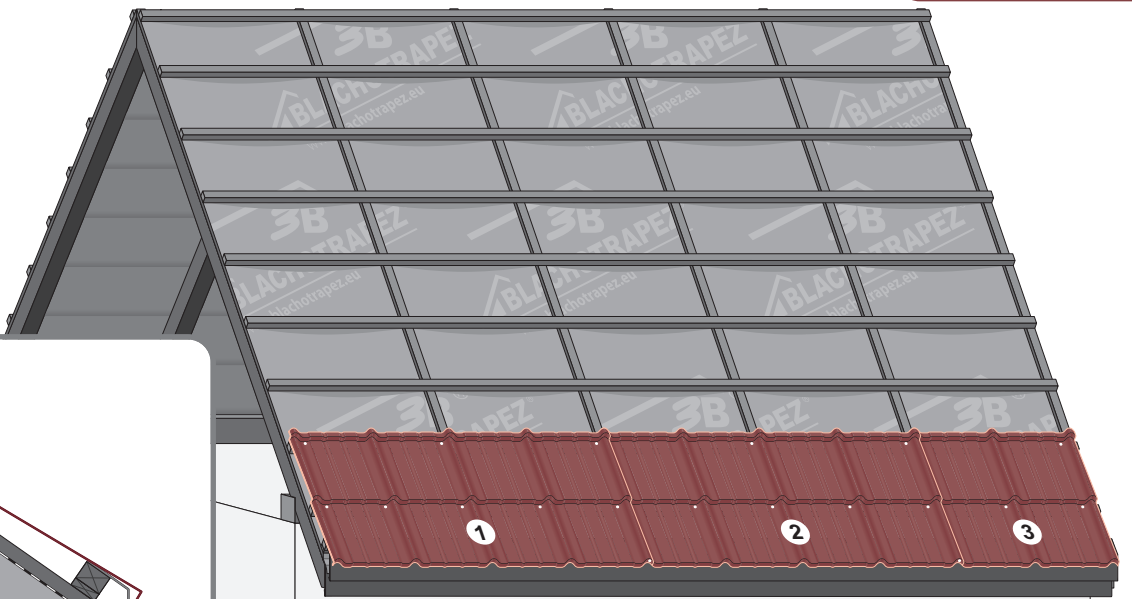
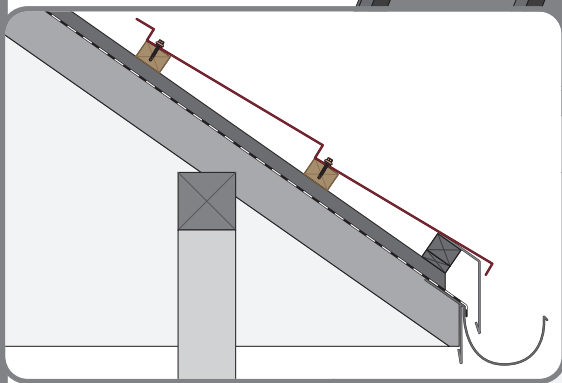
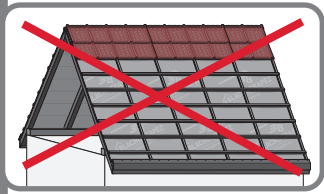
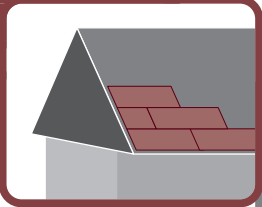

5b

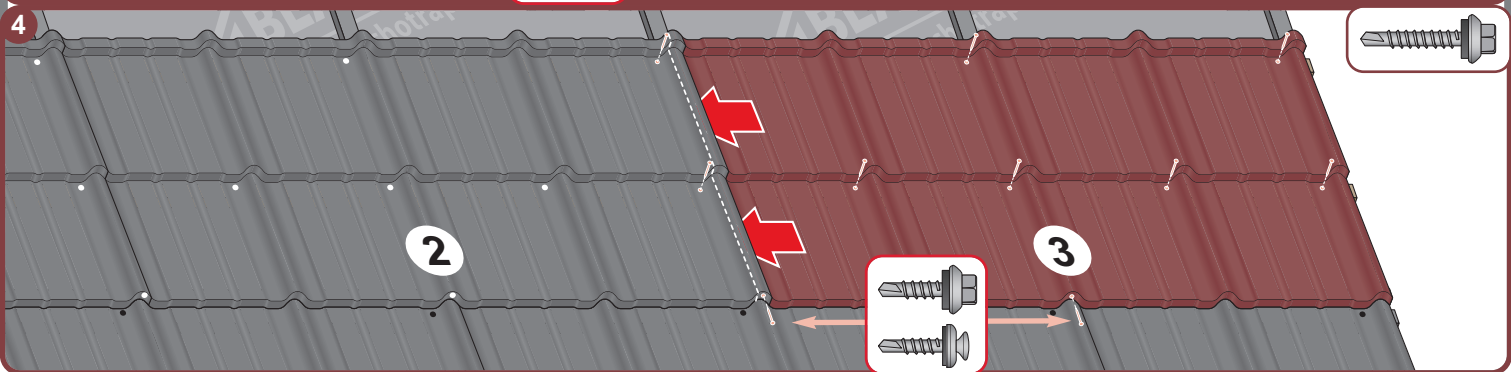
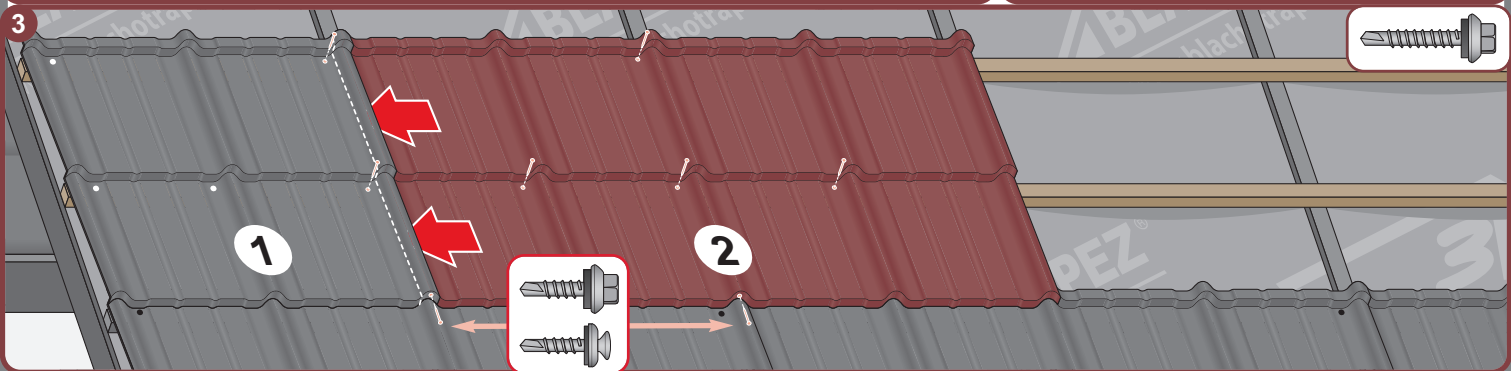
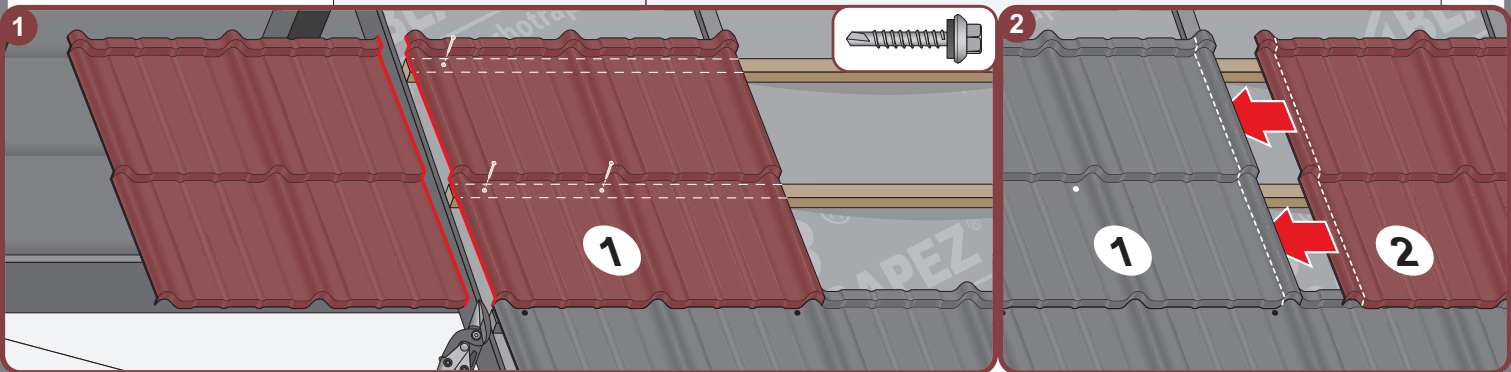
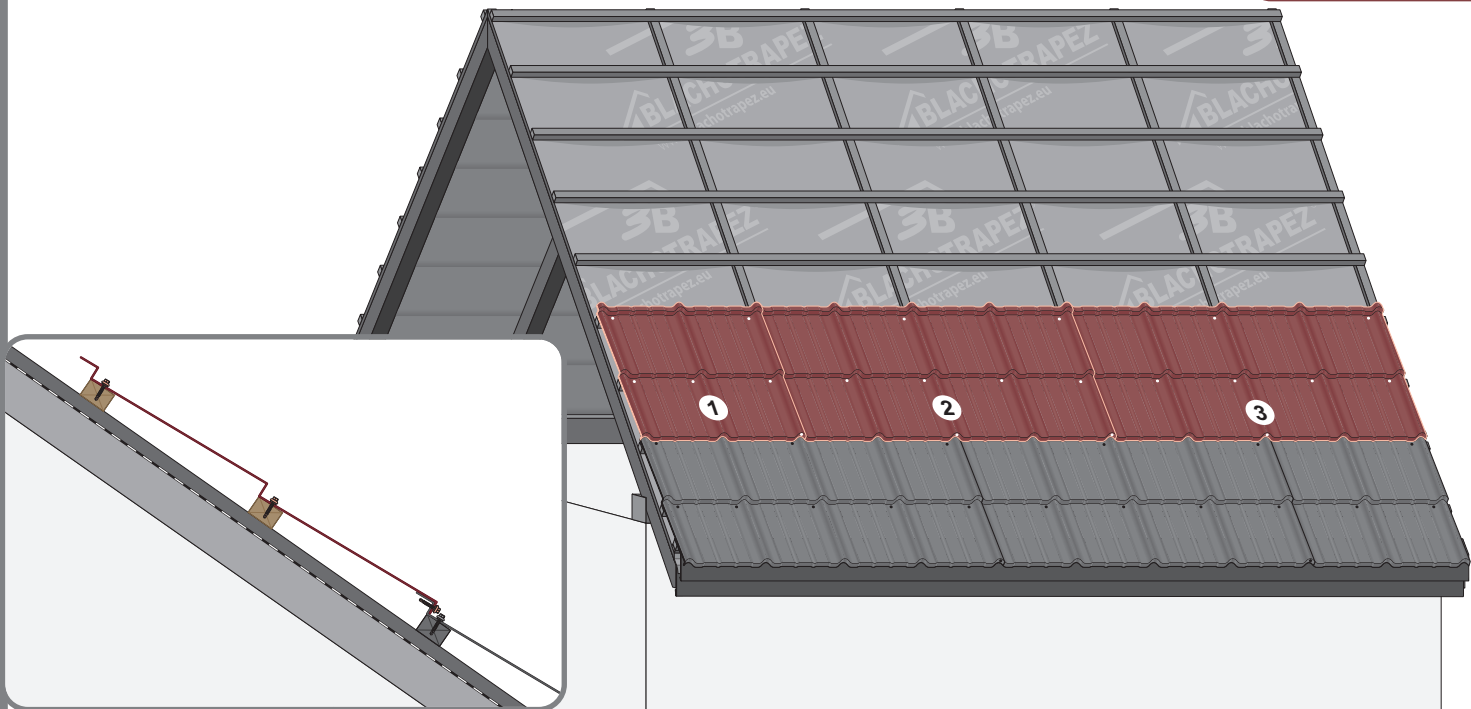
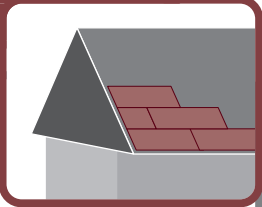

5c

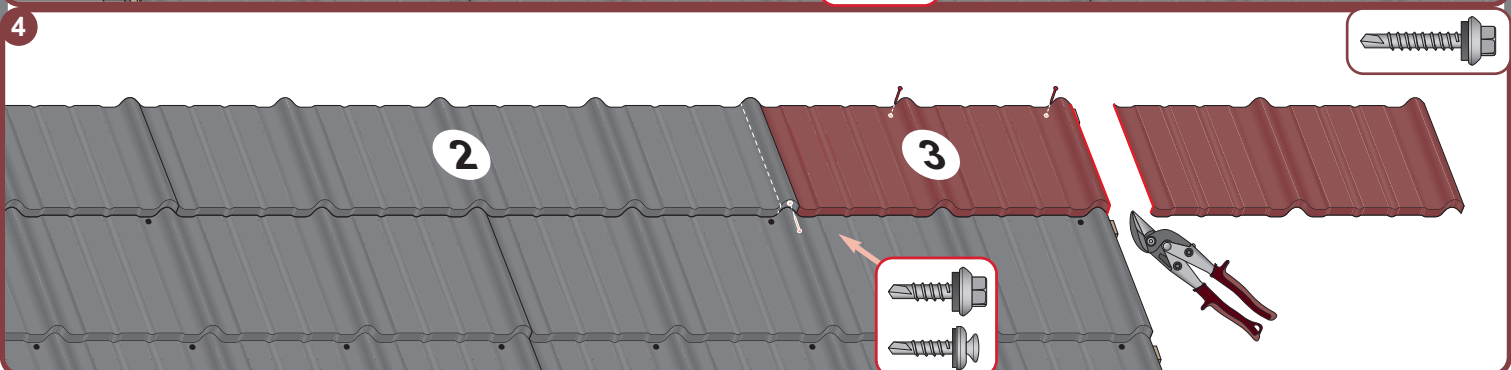
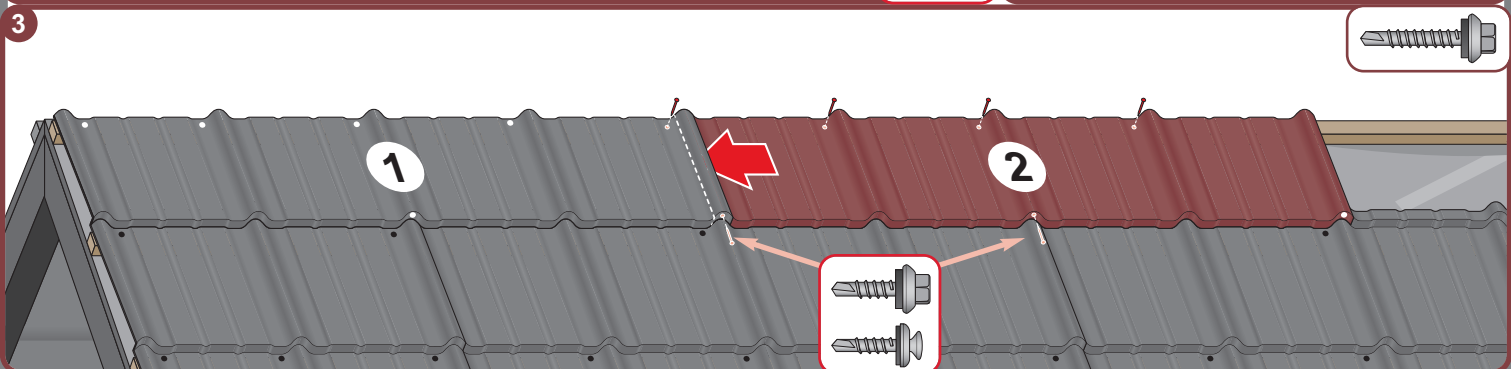
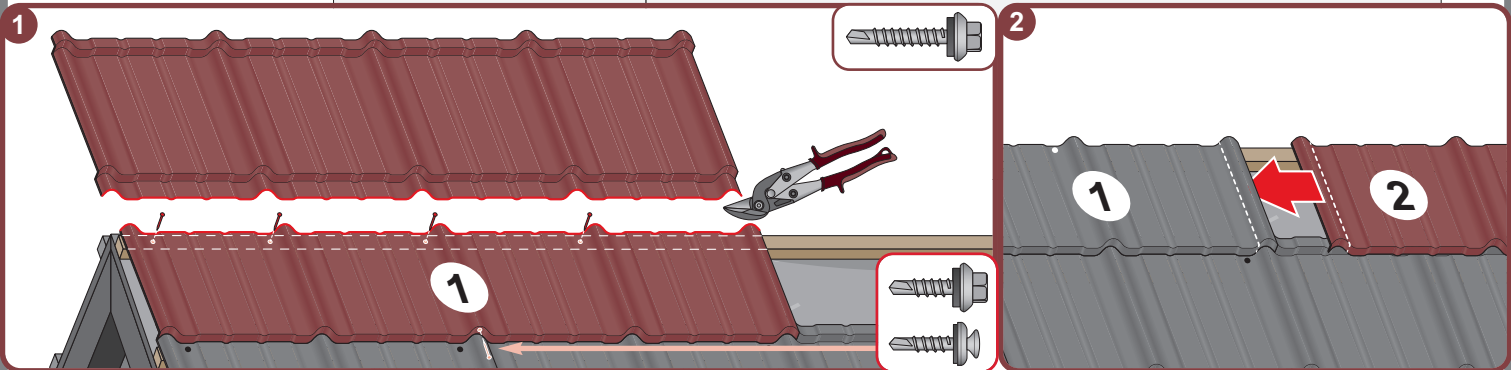
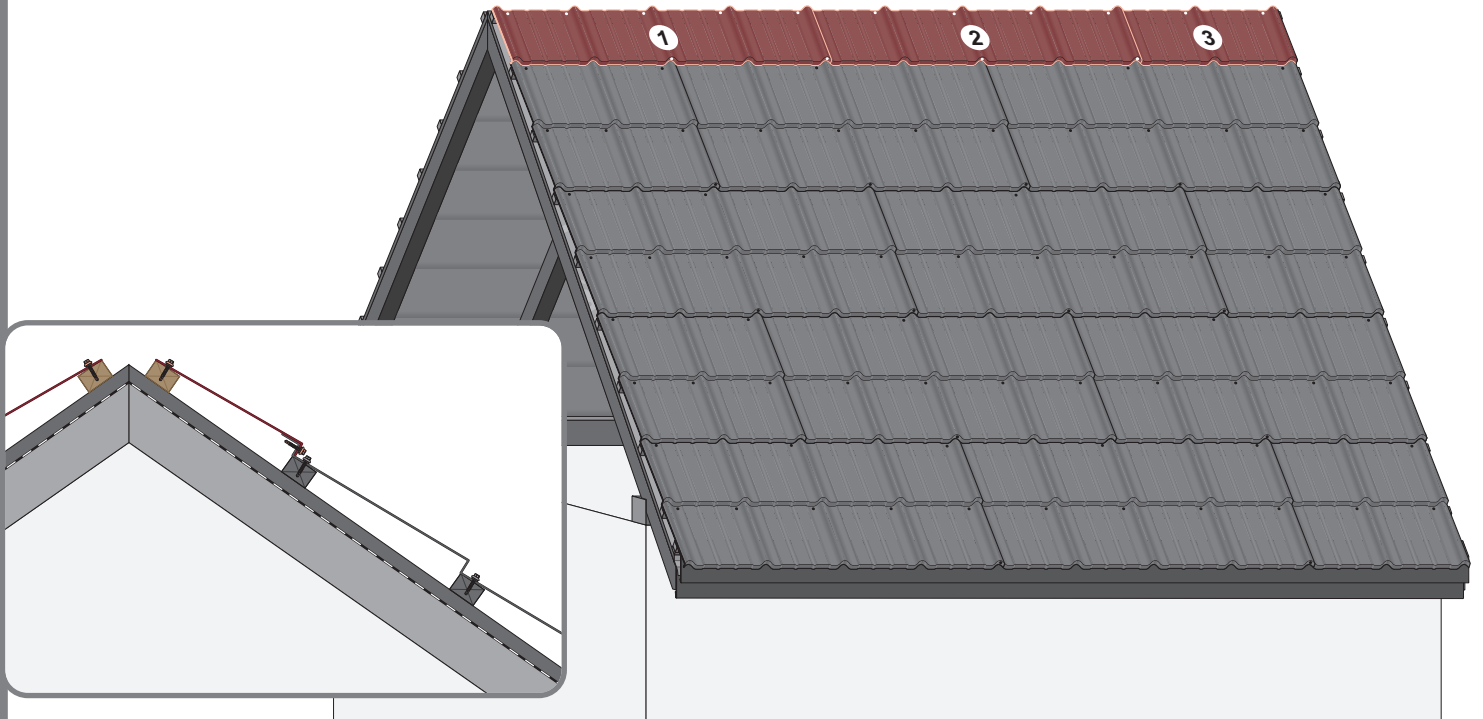
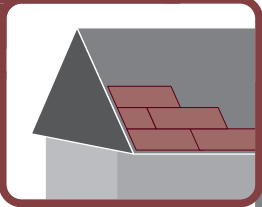

5d

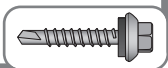
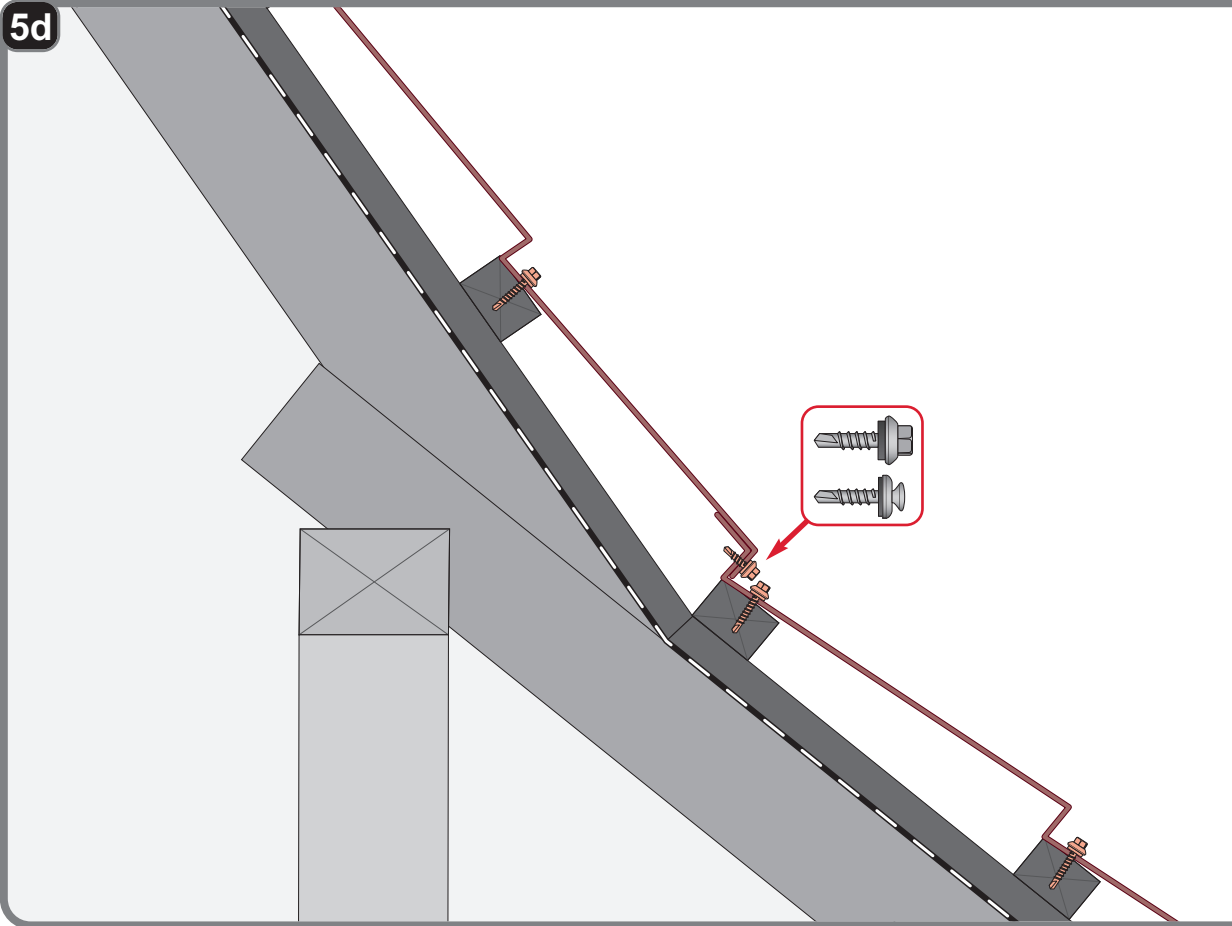
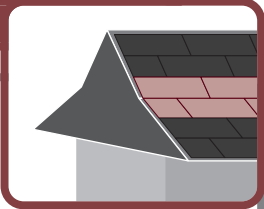

5e

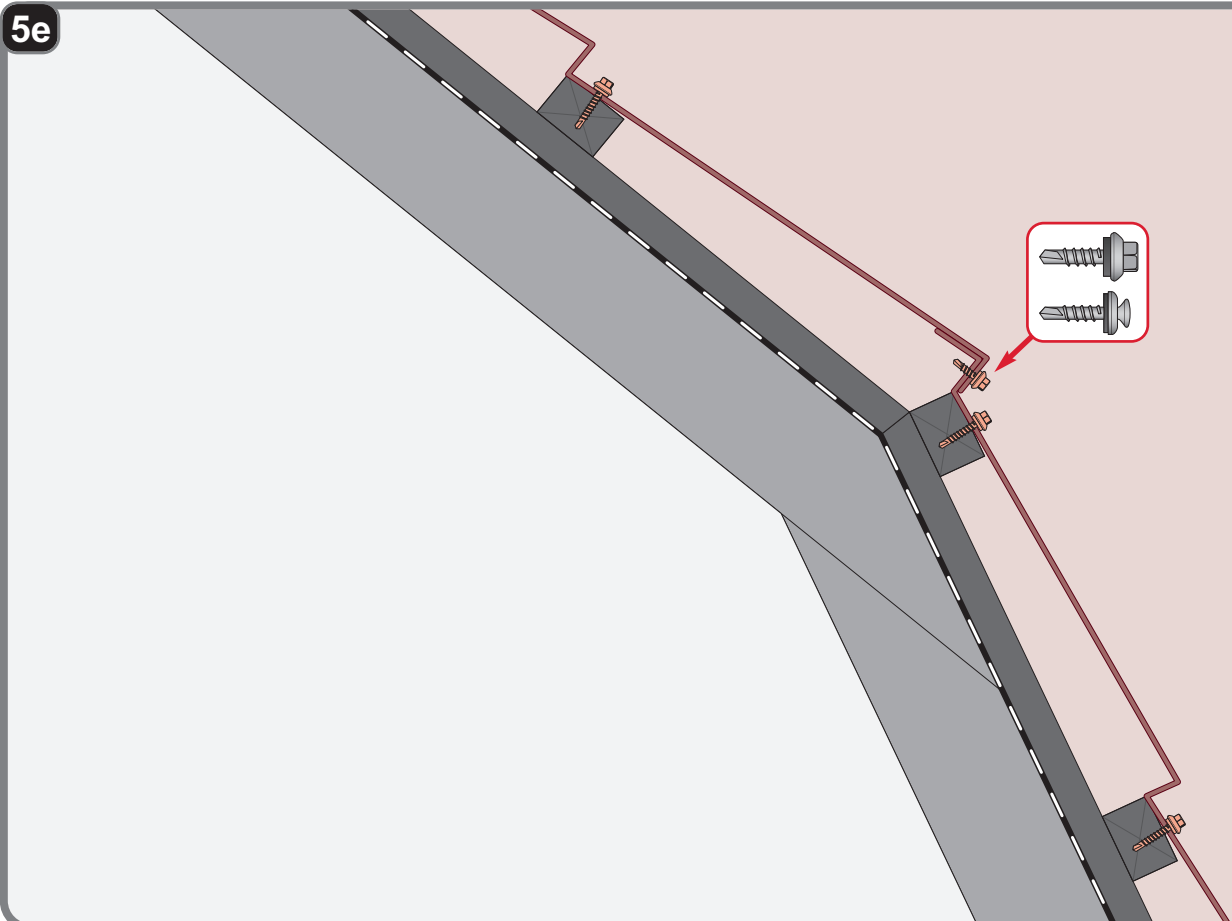
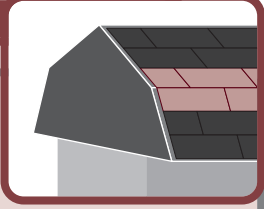

6a

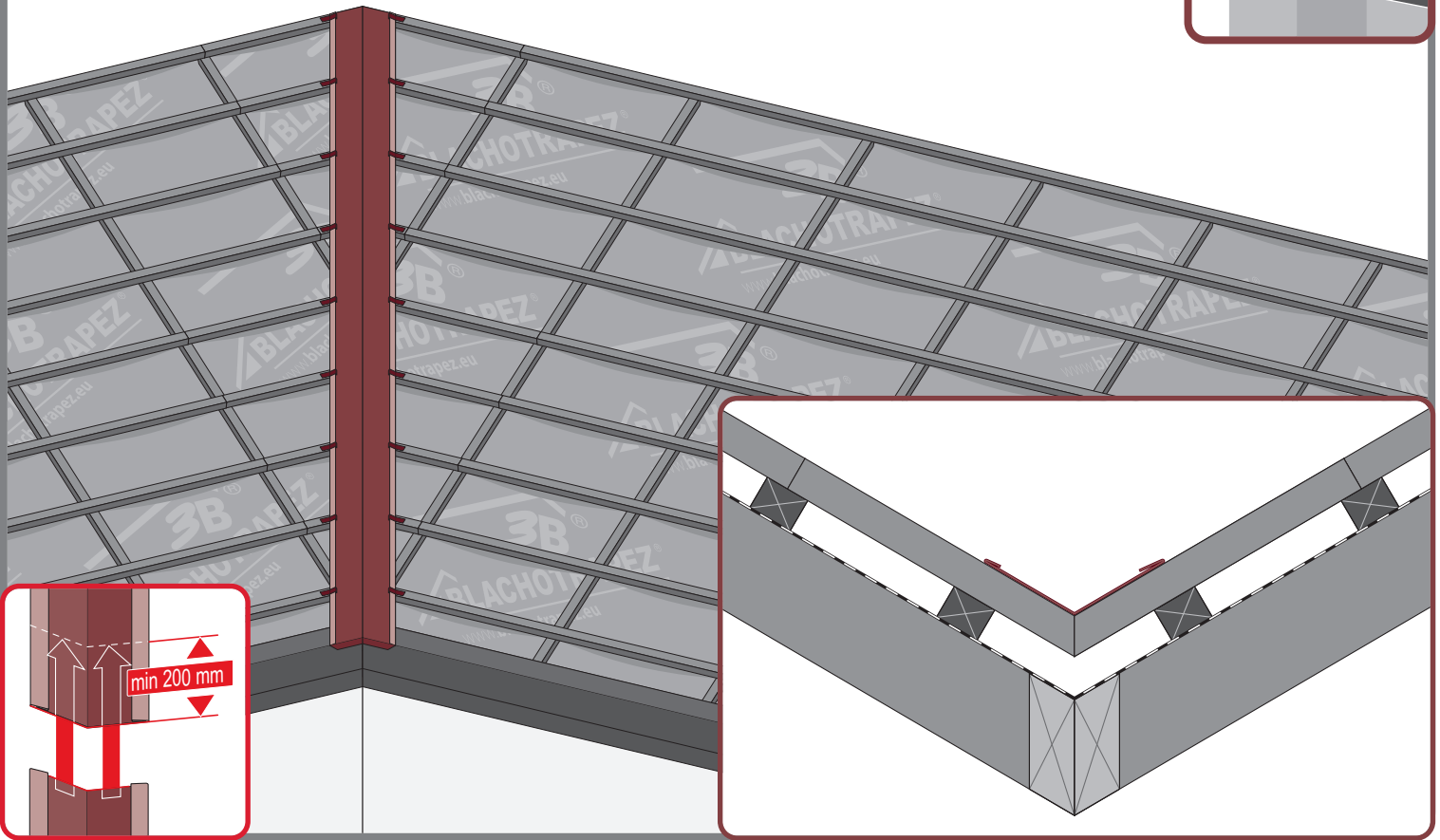

6b

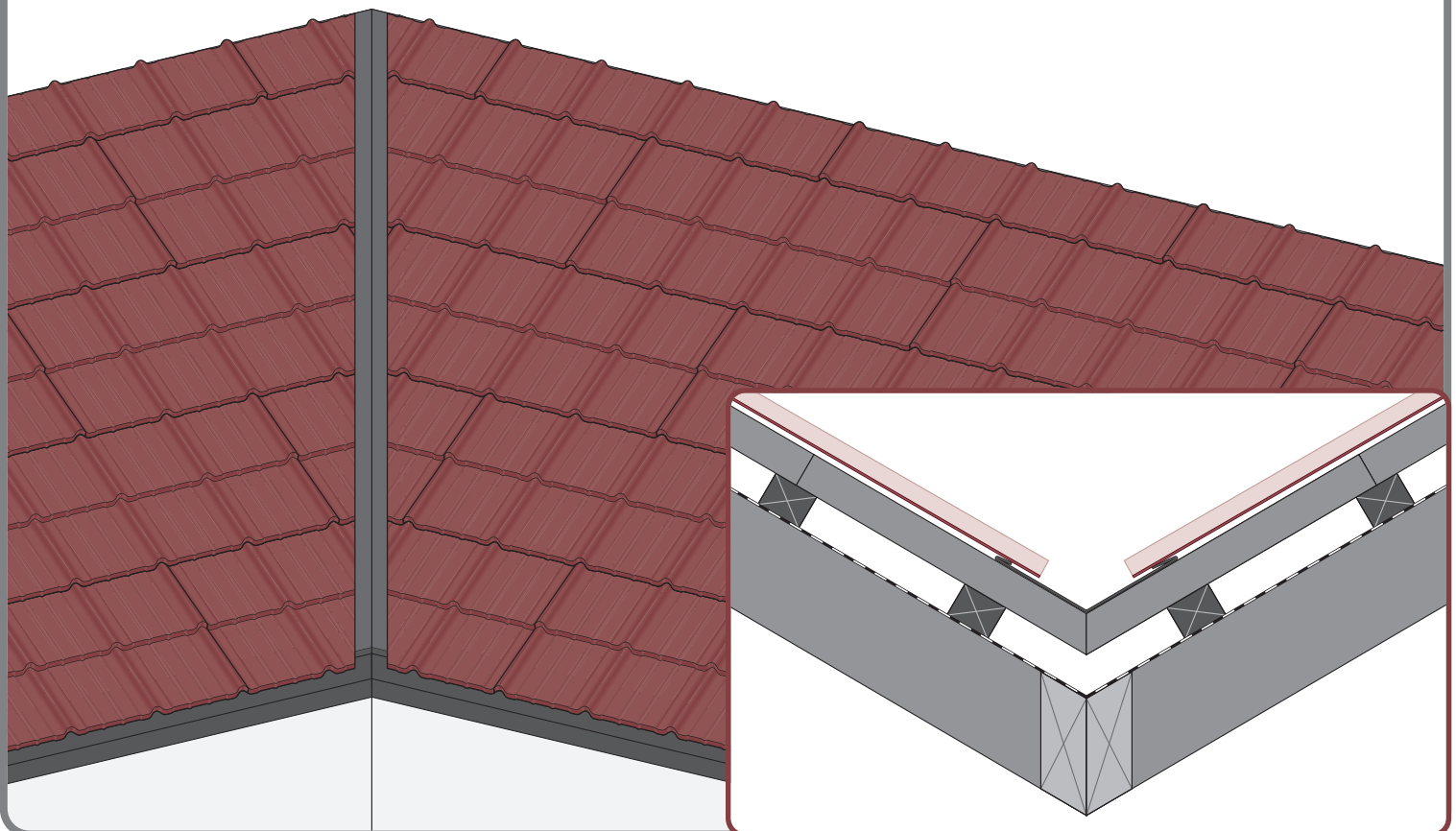

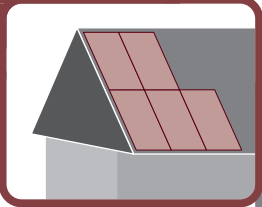

7a

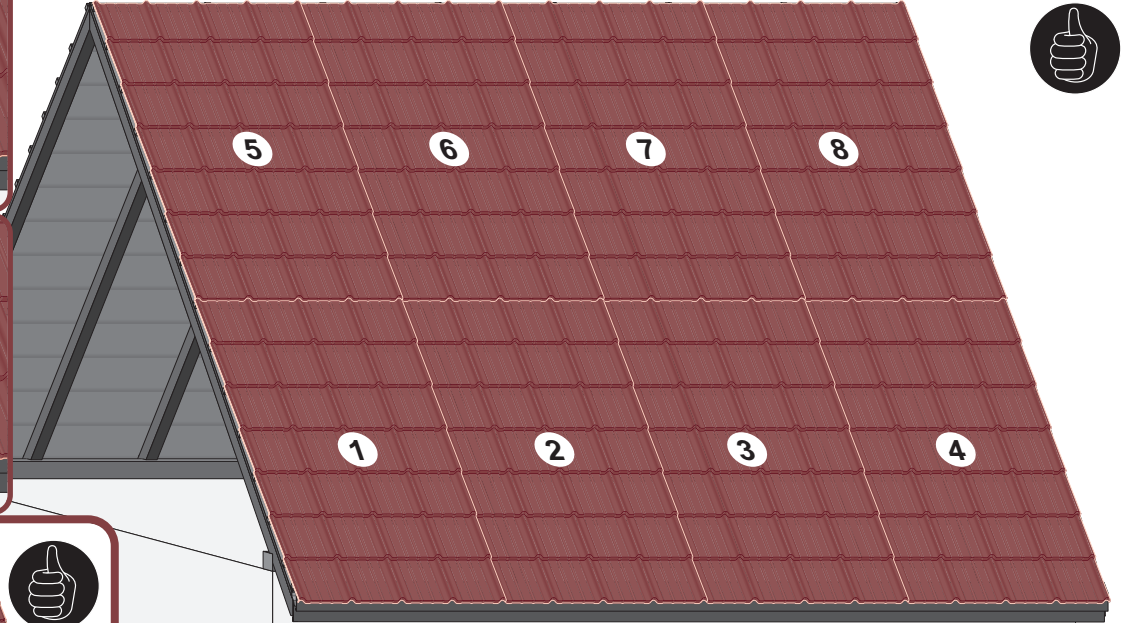
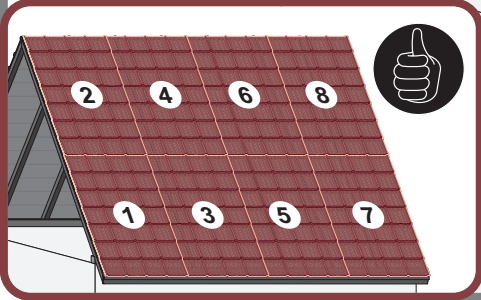
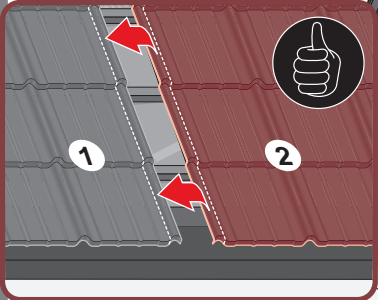
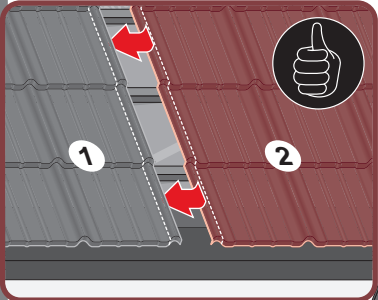

7b

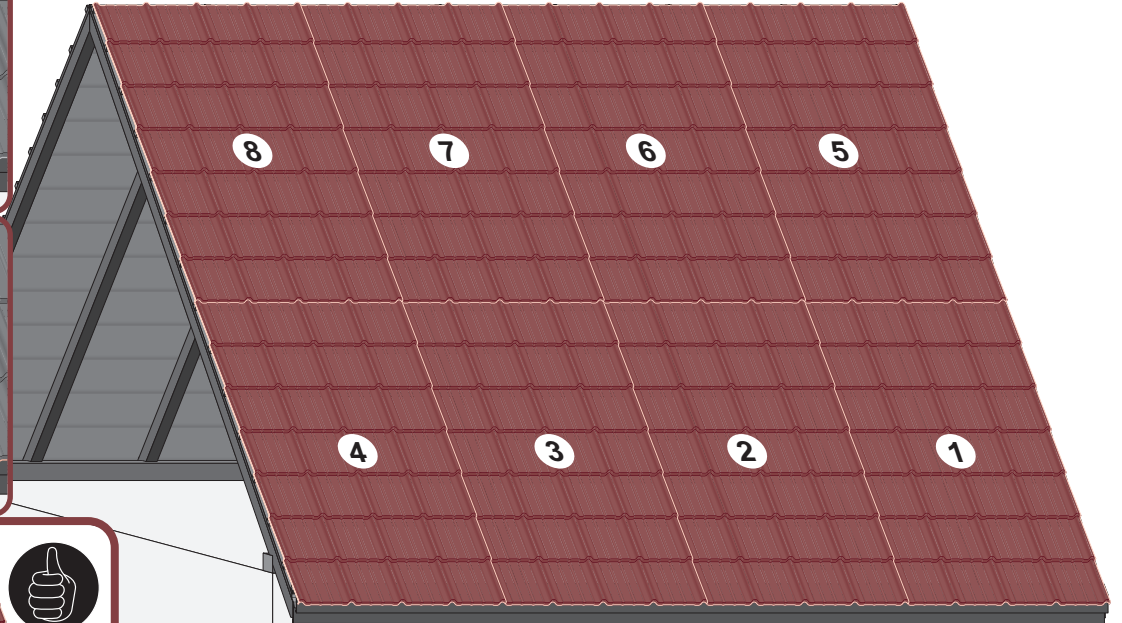
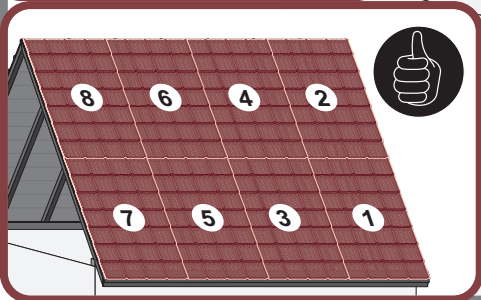
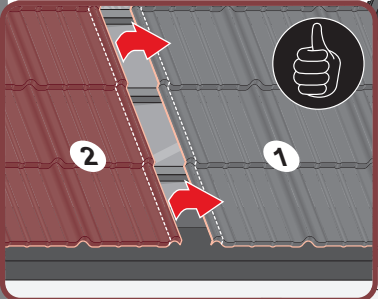
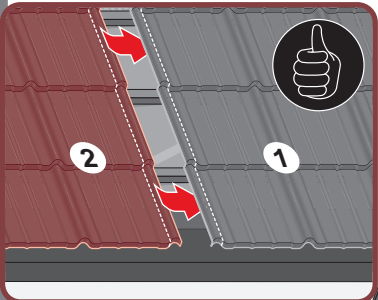

8a

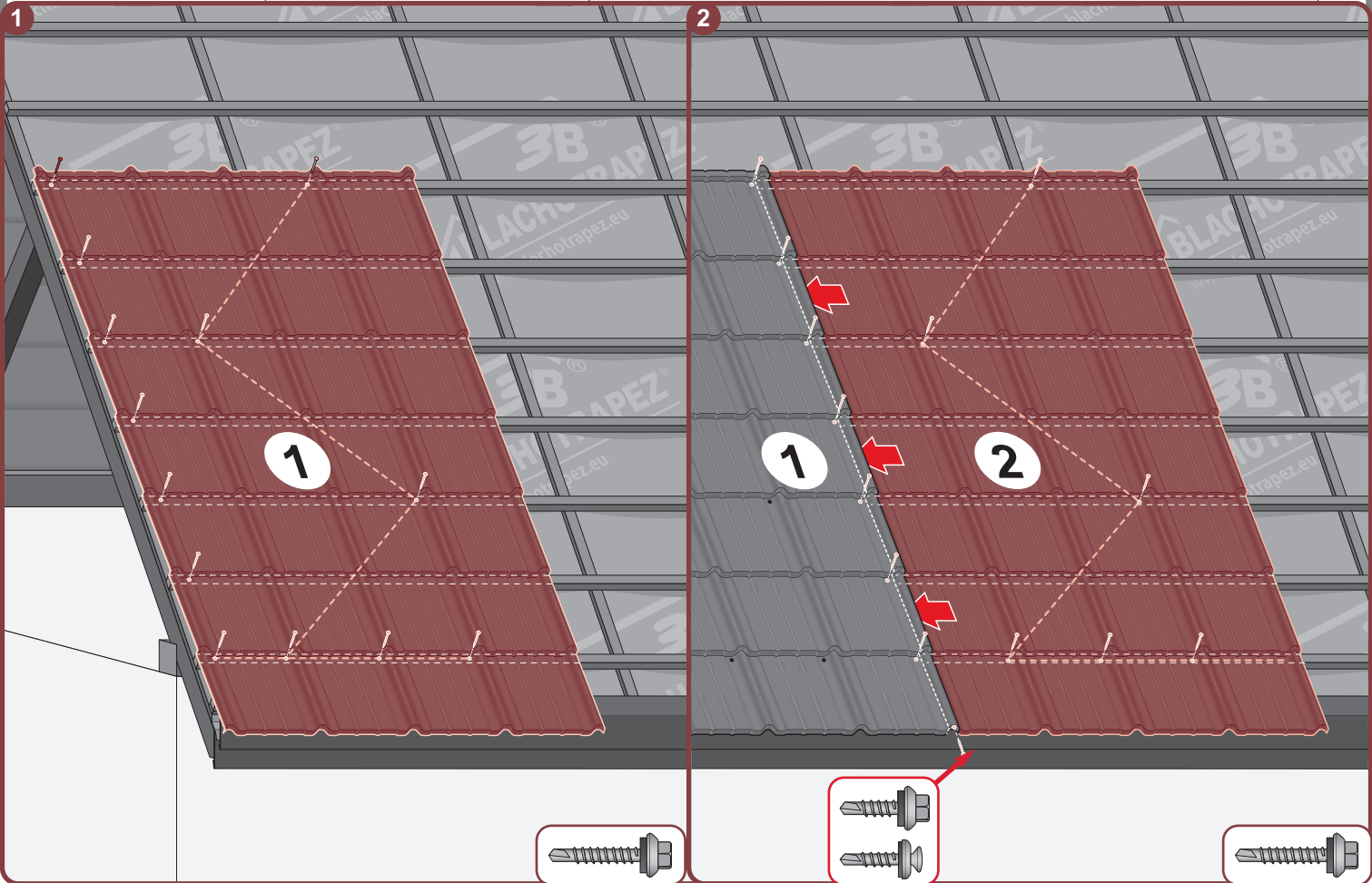
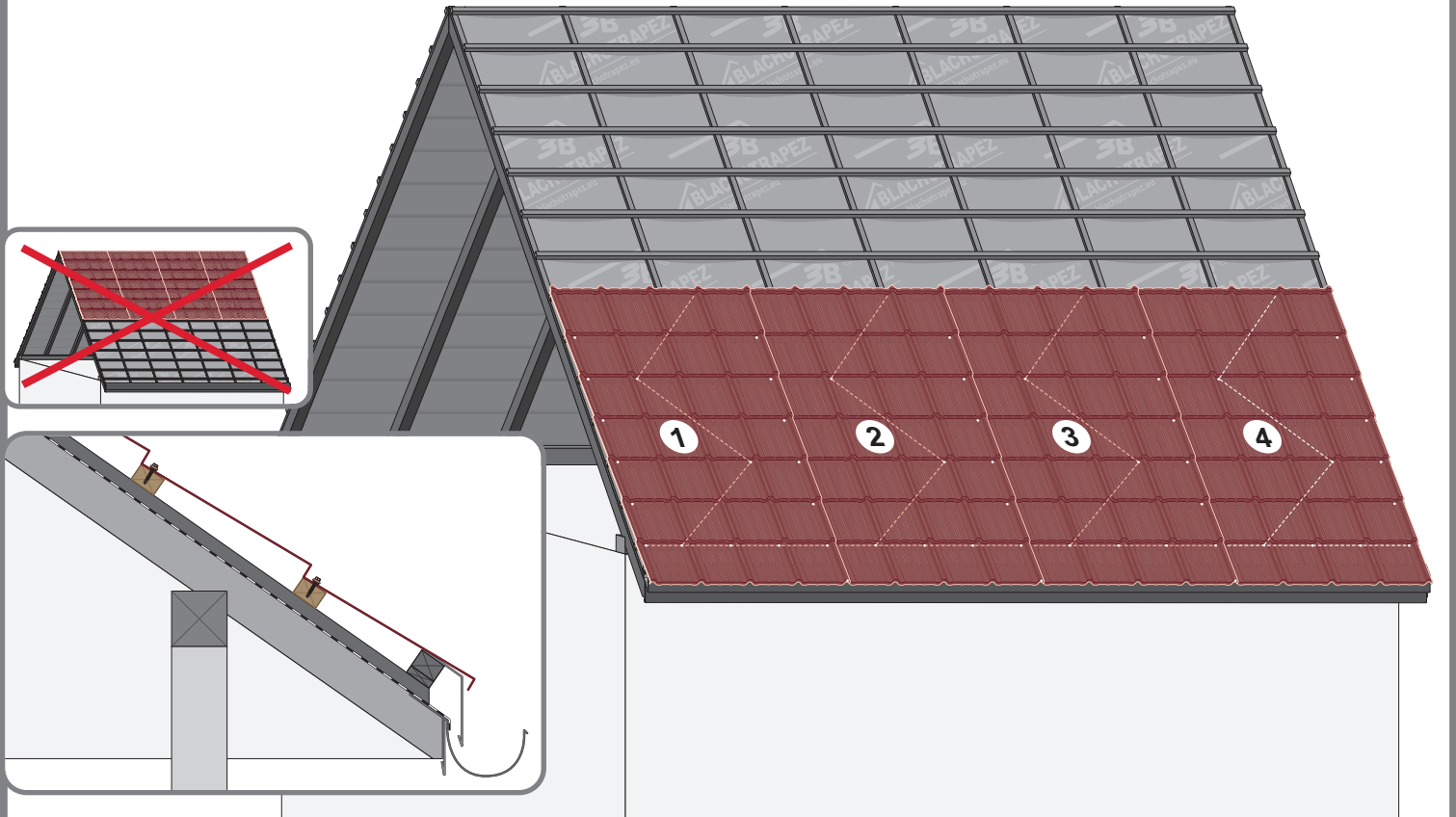
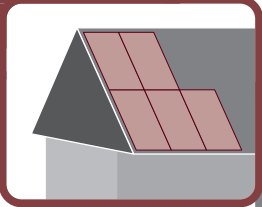

8b

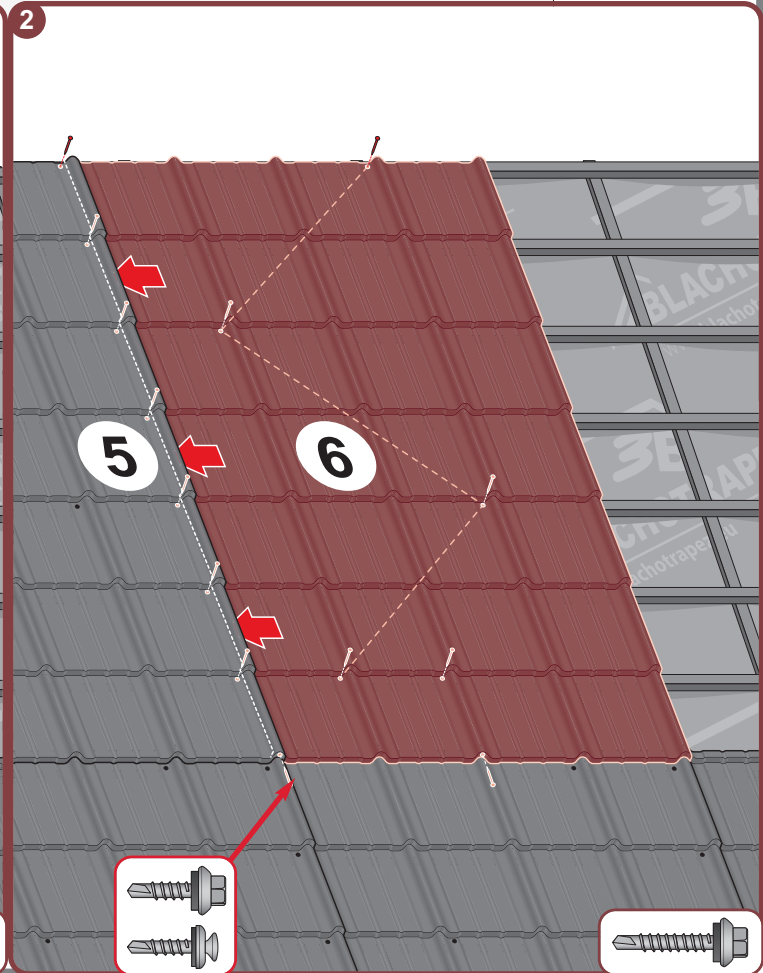
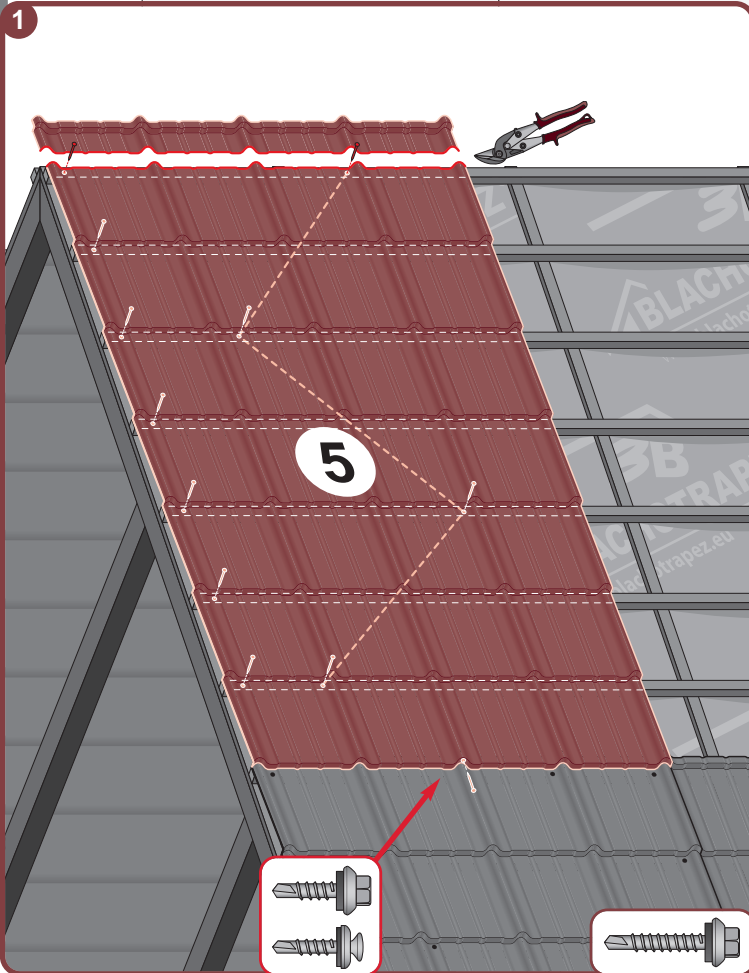
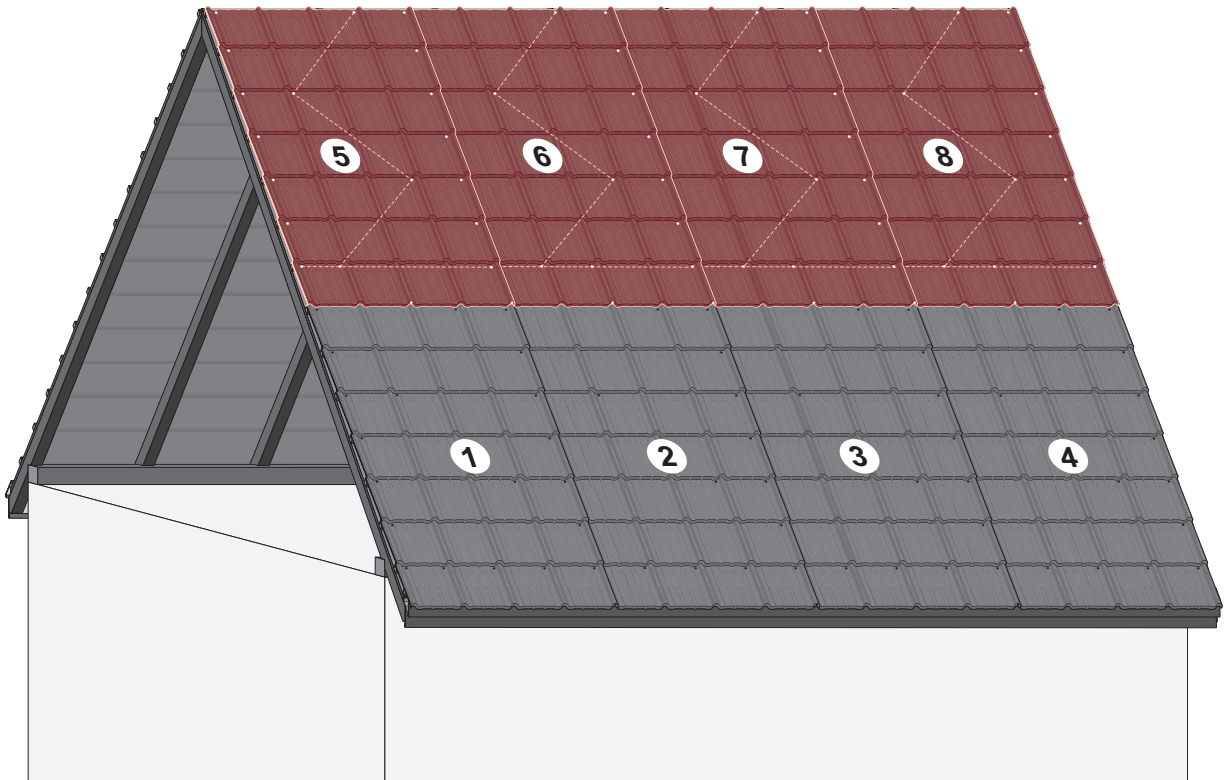
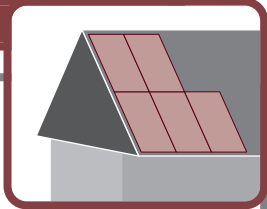

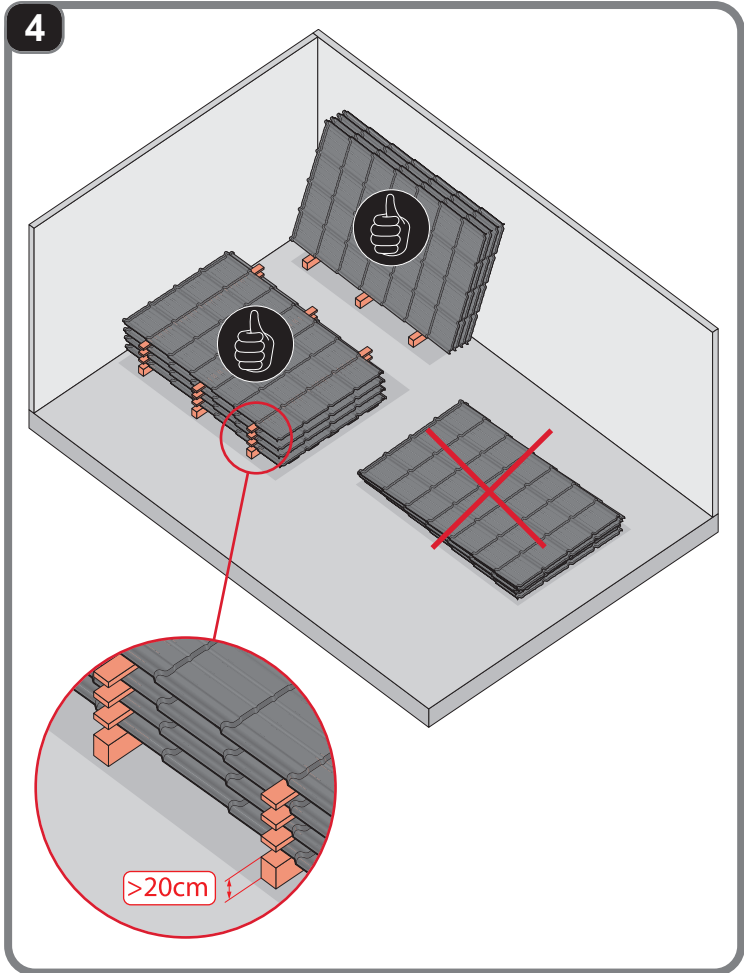
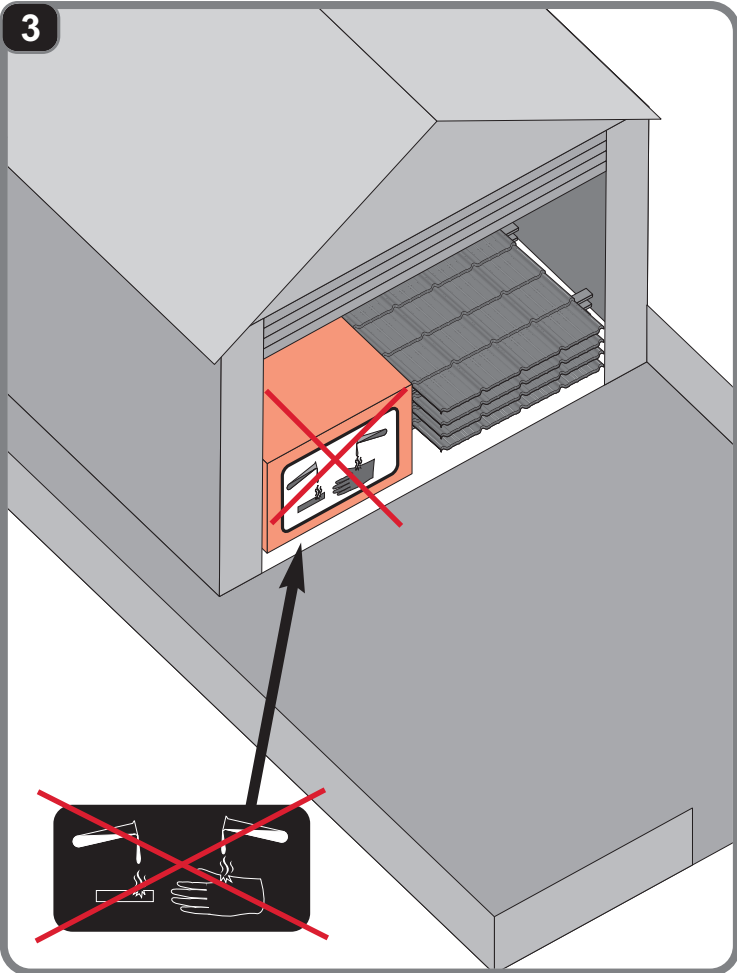
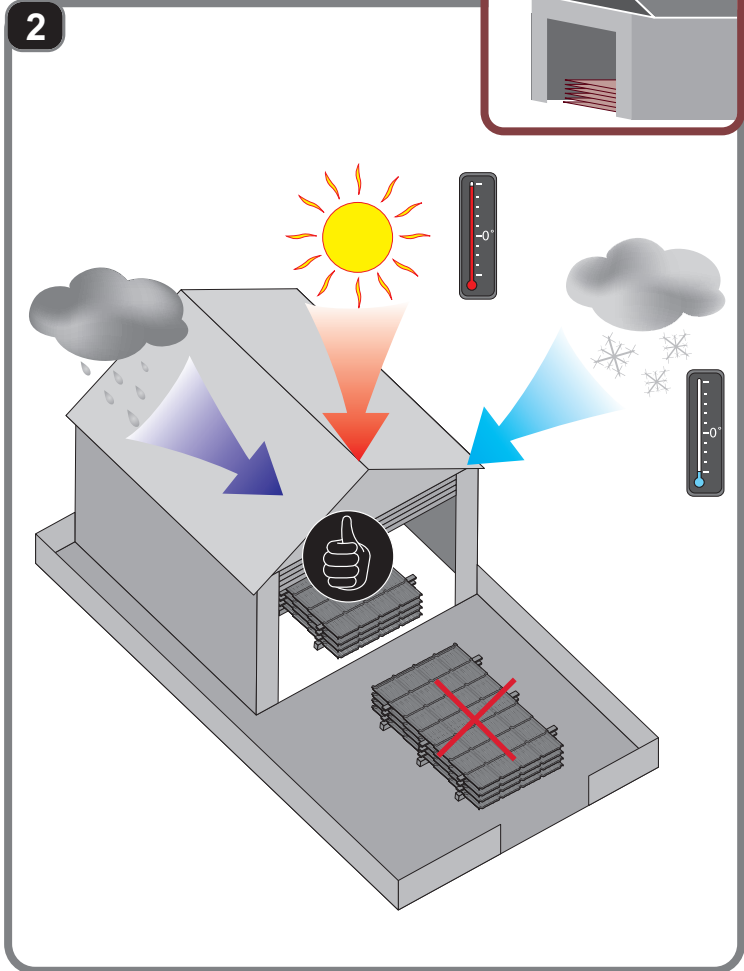
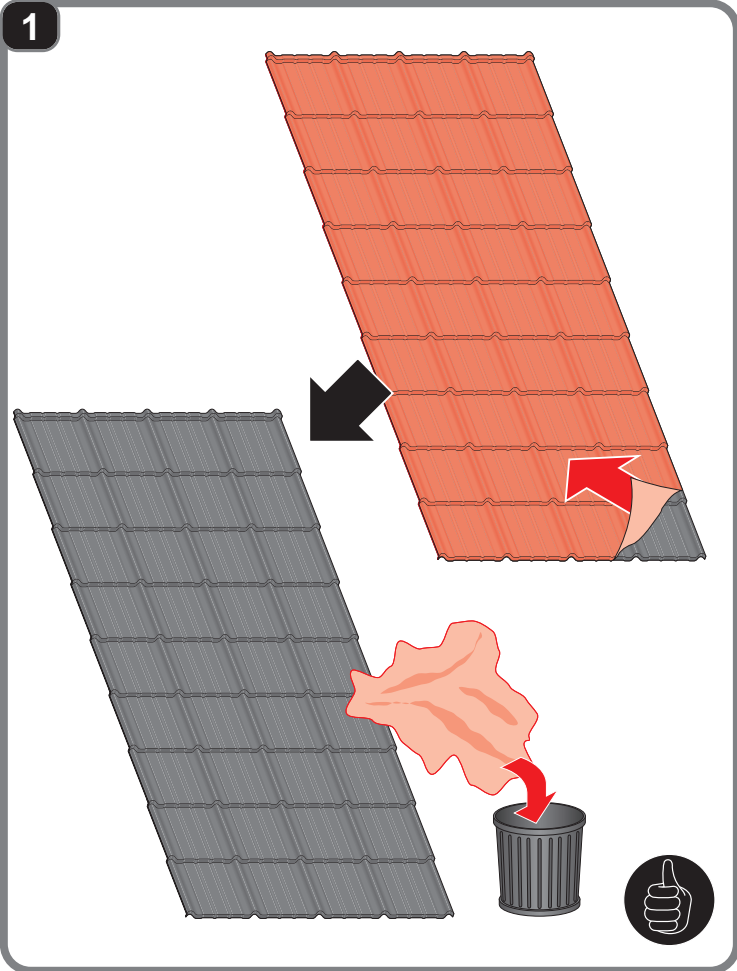

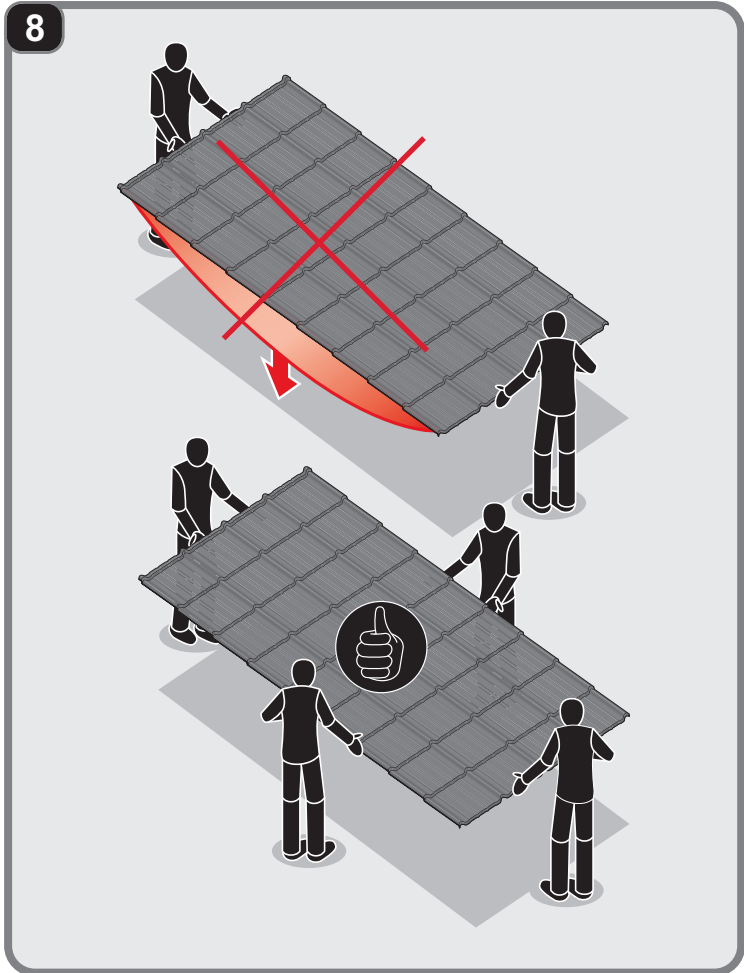
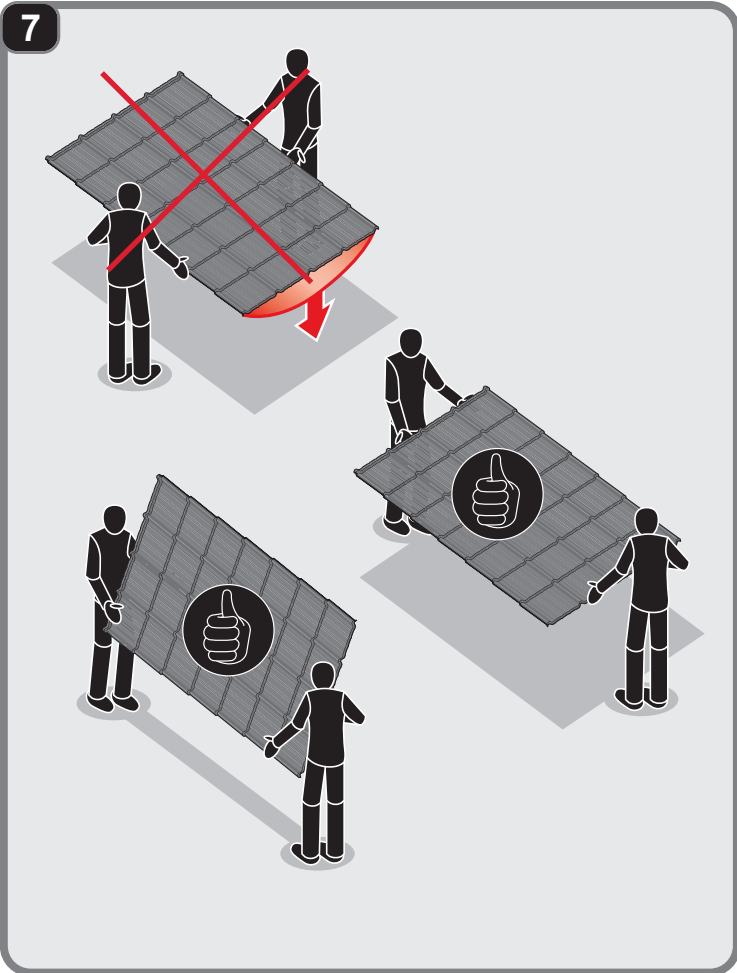
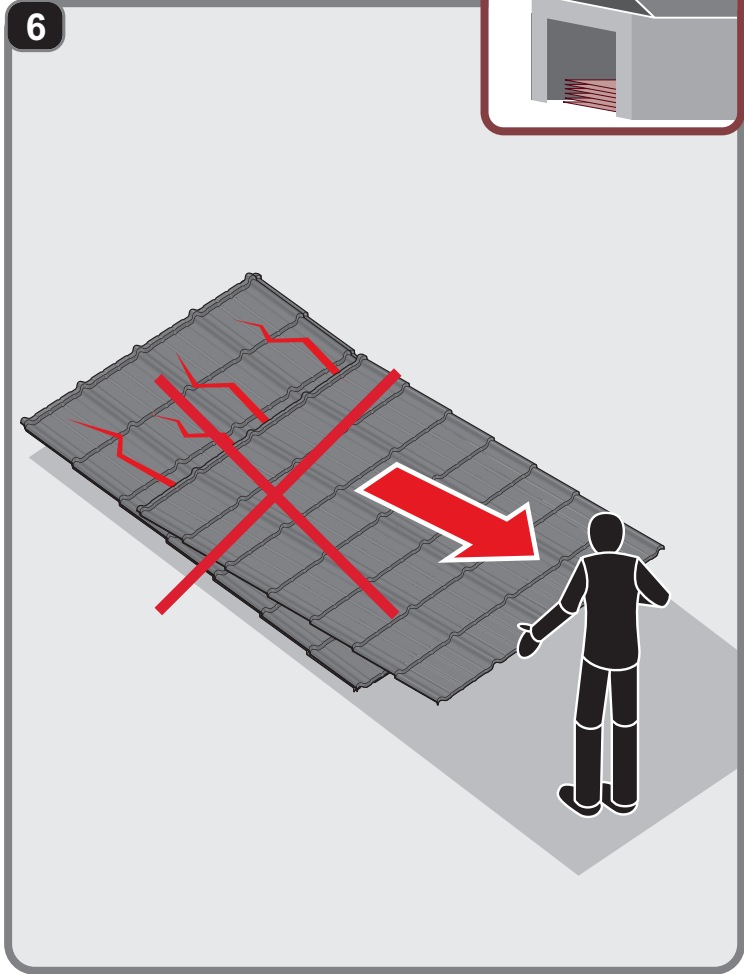
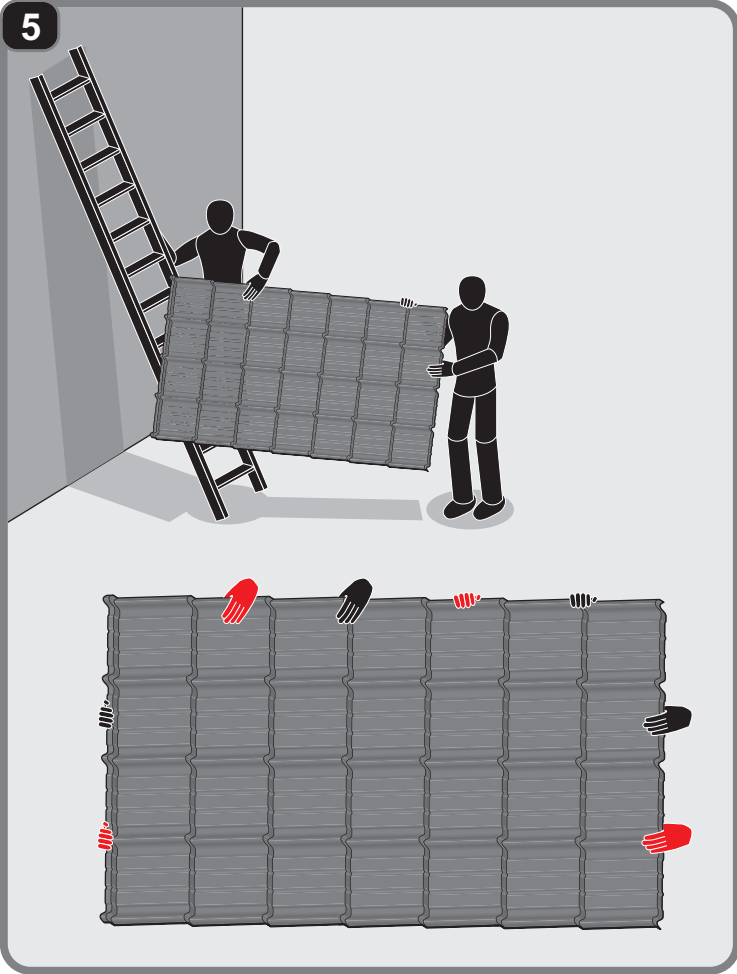
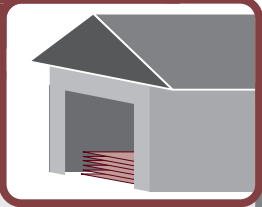



BLACHOTRAPEZ Sp.z o.o.

ul. Kilińskiego 49A

34-700 RABKA ZDRÓJ, POLSKA

tel. 18 26 85 200, fax. 18 26 85 215

[www. blachotrapez.eu](http://www.blachotrapez.eu)

blachotrapez@blachotrapez.eu

0420

Montaż blach dachowych wymaga wiedzy fachowej, specjalistycznej i doświadczenia. Niniejsza instrukcja jest materiałem poglądowym i nie zwalnia wykonawców z obowiązku przestrzegania zasad sztuki dekarzkiej i norm. Sposoby montażu przedstawione w niniejszej instrukcji mają charakter wskazówek ogólnych. Wymagana metoda montażu może różnić się od wskazanej w instrukcji w zależności od typu dachu lub rozwiązań regionalnych. Aby skorzystać z ogólnych instrukcji i wskazówek montażu, postępuj zgodnie z wytycznymi projektanta lub skontaktuj się z naszym działem wsparcia technicznego. Doświadczeni wykonawcy posiadają indywidualne rozwiązania, które Spółka BLACHOTRAPEZ akceptuje.